

1955

SOCCER FIRST MENTIONED IN TAUPO TIMES

SPORTS GROUND PLAN

Council Hears Deputation

On Wednesday evening, February 10, a deputation from Taupo sportsmen interested in the development of the Domain Sports Ground waited on the Borough Council. The deputation, which was introduced by Cr. M. Stanley, had been appointed at a meeting convened by Mr Stanley and held on Thursday, February 3, at which Mr G. A. Acres was elected chairman, and Mr F. D. Stretton secretary.

Members of the deputation were: Messrs Acres, O. Delaney, J. K. Bogue, J. W. Woodward, R. Staines, D. E. Baker, F. D. Stretton, and G. Foote. Mr L. H. Cheal was also present.

Views of Deputation

Opening for the deputation, Mr Acres said they wished to make certain suggestions to the Council re development of the sports ground. Their committee understood that the Council had established priorities for the development, and had recorded that it was in full agreement with first, the construction and grassing of the rugby football and cricket ground, and as next priority the construction of two basketball courts, on which it was considered tennis could well be played, while provision could be made for later extensions to the tennis basketball facilities.

There had been a request for a hockey and/or Association football ground also. Dressing rooms were considered essential, particularly for football and cricket, and could most economically be incorporated in one of the buildings to be built on the ground, either a grandstand or indoor sports building. A temporary dressing room might be the use of the changing rooms in the Memorial Hall allowed by the Council.

The deputation hoped the Council would be able to have the ground finished in time for an autumn season, to avoid sports fixtures being off the ground for a further season.

The deputation also wished the Council to consider granting the use of the Memorial Hall at concession rates for badminton, indoor bowls and table tennis.

Original Plan's Priority

Following Mr Acres remarks, the Mayor, Mr J. E. Story, said that the Council was agreed on first forming a sports oval for football and cricket, and then the basketball area. The Council had not yet discussed dressing rooms and other buildings.

Mr Foote said that the basketball courts could also be used in summer for the tennis courts. In reply to Cr. Stan. Mr Cheal, by whom the

(Continued from Page 4)

As exemplifying this, he mentioned that they had to advise the Commissioner of Crown Lands on the future use, and control of four acres of vegetation reserve on the State highway at Turangi, a matter on which Mr O'Keefe said he would be consulting local residents. Then there had been the investigation of a forest company's request to put a private telephone line along some County roads.

Other matters had concerned a delegation of one of the principal State highways, the investigation of new divisions in Acacia Bay, Granddell's Block, the Potts Estate, Waihanui, Turangi, Waitetoko, and Whakamaru, and the giving of evidence to the Liquor Control Commission regarding conditions affecting liquor licences in those parts of the County which were in the King County.

The future of Mangakipo town and a hearing on the possible new town site near Whakamaru was another item of problem, still another being the dealing with complaints received from the Health Department regarding cases which were regarded by the Department as being serious health hazards in different parts of the County.

scheme for the Sports Ground development had been prepared, said he would like to see any hockey and/or soccer field placed elsewhere, as there would be minimum room only for it and very little for spectators.

Cr. Swan thought they would get into difficulties if they cluttered the Sports Ground up now, and suggested future use of the Loughton Street reserve. Both councillors and members of the deputation expressed general agreement that the matter of hockey and soccer grounds should be postponed for the moment, Mr Woodward urging that they stick to Mr Cheal's plan at present.

Cars on Ground

Mr Cheal said he would like to see cars kept off the Sports Ground. Mr Woodward agreed, saying that even at Eden Park cars and buses could not get on the ground. Taupo people must give up the idea that they could sit along the sidelines in cars, which took up too much spectator space. Mr Acres thought there might be an advantage in cars on the ground on wet days, for dressing purposes. The Mayor commented that if they had cars on the ground, on the light Taupo soil, they would have no grass.

Cr. Swan said everyone seemed satisfied with Mr Cheal's original plan. What was the Committee's opinion re sowing, whether there should be autumn sowing, or whether the ground be left longer to consolidate and have a spring sowing?

Spring Sowing Favoured

Mr Cheal said that his original estimate of the cost of the forming of the sports oval was dependent on the use of the most suitable modern earth-moving machinery, as made clear at the first public meeting. He had seen a contractor that morning, who had been highly recommended by Mr J. A. Andrew, M.O.W. engineer, and the contractor thought he could have the job done by the end of March if instructed soon.

The contractor could give a quote if requested, up to the stage of grassing the ground. Any soil from outside would have to be brought in by the Council.

Mr Woodward said there was only one way of shifting the soil, namely, with carry-alls. Bull-dozers to push it about were out of the question as far as costs went. If they could get the ground ready for sowing next month they should do so and keep faith with the cricket and football people. If they had spring sowing there would be no play on the ground next summer.

Re levelling the ground, he understood that Mr Cheal was willing to supervise the job when machinery was available, and he thought Mr Cheal should be asked to go ahead and finalise arrangements with the contractor.

The Mayor, Mr J. E. Story, said the only way was to complete the plans and specifications and then get the quote for the work.

Cr. K. E. Young said the news that suitable machinery was available was the best they had had. They should push on with all possible speed. If they did not sow until the spring there would be no football on the ground the following winter. He would like to see it sown by mid-March, but in April would be better than the spring.

Indoor Games In Hall

Mr Bogue mentioned indoor games, such as badminton, table tennis and indoor bowls, being allowed in the Memorial Hall, and asked what the Council had against using the hall for them.

Cr. Young said the Council had not yet discussed the suggestion made by Mr Bogue. Mr Woodward said that some councillors had indicated badminton would not be allowed in the hall.

Mr Staines mentioned that a badminton court would be marked on the floor in white, and when once polished the marking had no effect on dancing and it was done in halls all over the country. The hall could be used for badminton and indoor bowls on the same night.

Cr. Morris said he had seen badminton players in Rickitt's Hall throw buckets of water on the floor. Was that necessary? Mr Acres said he had not seen it done on a badminton floor anywhere else, and it was not necessary.

With regard to reduced hall charges for such indoor games, Mr Bogue pointed out that use of the hall for games could be conditional on the hall not being otherwise booked. It would be sufficient if the indoor games people were given a week's notice that the hall would not be available on the following week. The hall would thus benefit by being used for sports purposes when not booked otherwise, while the full charges would be received for ordinary bookings. The additional reduced charges for sports-bookings would be received in addition.

Mr Woodward said the council could arrange with the badminton people to have a trial game in the hall, so that the Council and the Sports Committee could see the result. Cr. C. S. Currie said he was in favour of badminton in the hall. He had seen it in halls elsewhere and was sure it could be played in the hall safely.

Mr Acres then thanked the Mayor and Councillors for hearing the deputation, and expressed confidence that the Council would consider what had been said. The Committee would like to meet the Council again when other matters cropped up.

The Mayor said they would be happy to meet the deputation again. He said he and the Council had every confidence in Mr Cheal, who had always been ready to advise them, and they would confer with Mr Cheal without delay on the matter of a contract for the work.

NEXT MONTH'S THEATRE

Two Plays Coming

Two flesh-and-blood plays are to be presented in Taupo next month, one by the Community Arts Service, the other by the Taupo Dramatic Society.

The C. A. S. production, Shakespeare's comedy "The Tempest," is being produced by Harold Baigent, well-known to Taupo audiences, while amongst the players is Arnold Goodwin, whose outstanding work as producer for the Taupo Dramatic Society's presentation of "Blithe Spirit" played a big part in the successful establishment of the Society. "The Tempest" is to be presented on Thursday, March 3.

"Wasn't It Odd?" is the intriguing title of the very bright comedy, by Kenneth Horne, which the Dramatic Society will present on Tuesday and Wednesday, March 8 and 9. An extremely novel situation is cleverly exploited by the author, and the ingenious plot, delightful dialogue and clever characterisation combine to make this play outstandingly attractive. "Wasn't It Odd?" is under the direction of Dulcie Cohen.

Both plays are to be staged in the Taupo-nui-a-Tia War Memorial Hall. Members' priority bookings for "Wasn't It Odd?" open on Monday next, February 21. In accordance with the expressed wish of the Society's Annual General Meeting it has been decided by the Committee that members shall pay 2/6 for their seats at public productions. The position now is that Dramatic Society members are entitled to priority booking of one seat at 2/6, and two further seats at 5/- each, if they so desire. Public bookings will open on Monday, February 28.

In the case of the C.A.S. production, preferential bookings open at the Taupo Book Club on February 18, and public bookings on February 25.

Golf Club Meeting

The annual general meeting of the Taupo Golf Club is to be held in the clubhouse at 7.30 p.m. on Monday, February 28. Details as to nominations for election of officers are advertised in this issue.

OPTICIANS.

FLETCHER & WILSON

ROTORUA.

Appointments at

D. HANSBY.

FIRST MENTION OF SOCCER IN TAUPŌ TIMES

OPTICIAN

G. T. A. McCLELLAND

F.S.M.C. (London)

WILL VISIT TAUPŌ ON SATURDAY 26th FEBRUARY.

For Appointments Ring

MR. G. FRASER,

CHEMIST—TAUPŌ.

CURRY FIRST AID OUTFITS

In the Plastic Container at 18/9.

A Must for the Motorist.

BATHING CAPS.

KWIK-TAN.

SUN GLASSES.

ALL HOLIDAY REQUISITES.

AT

HANSBY'S PHARMACY

NEXT TO BREAD SHOP

ELECTROLUX TAUPŌ DEPOT—DOWELL'S, FURNISHERS, TONGARIRO ST.

Call or telephone for Service, Parts or to arrange Free Home Demonstration on Agent's next Monthly Visit. Latest Model on display. Phone: 128 M.

YOUR DUTY TO YOUR BEAUTY.



A Complete Range of these World-renowned

COSMETICS

is available at

TAUPŌ DRUG STORE

OPPOSITE POST OFFICE.

Phones: Shop, 130 S. Res., 140 M.

MRS. N. DAWSON,

DRESSMAKER.

FROCKS. WEDDING GOWNS. SUITS. EVENING GOWNS.

Outside a Specialty.

SKREEN'S BUILDINGS, TAUPŌ.

BOOT REPAIRS.

CREPE REPAIRS A SPECIALTY.

B. ROBERTS.

TUWHARETOA STREET

(Near Majestic Theatre).

TRUTONE DRY CLEANING

AT

TAUPŌ DRY CLEANERS

Corner Horomatangi and Ruapehu Streets.

R. DAWSON.

LICENSED DRAINLAYER.

Prompt Attention. Estimates Given.

TAMATEA AVENUE,

APPLY TIMES OFFICE.

1956

FORMATION OF TAUPO UNITED

Public Notice

THE TAUPO TIMES.

Correspondence or Enquiries should be addressed as follow:—

EDITORIAL OR ACCOUNTS—

Box 93, Taupo.

Page 262.

ADVERTISING OR PUBLISHING—

Box 199, Taupo.

Page 251.

TAUPO TIMES DEPOT—

Mr. M. L. Svensen,

State Agent, Heuheu St.

ANNUAL SUBSCRIPTION—

Postage Paid.

ADVERTISEMENTS AND

ADVERTISERS—

Please note that News Copy and Display Advertising Copy for an issue should be received on Saturday of the previous week. Classified Advertisements should be received by 5 p.m. on the day prior to issue.

TAUPO LADIES' GOLF CLUB.

Annual General Meeting will be held at the Clubhouse on Friday, March 8, at 8 p.m.

McKELVIE, Hon. Secretary.

FOUR-STAND Wool-shed. Prices

bought on either labour only or in contract basis for erection of Four-stand Wool-shed at Ngamata Bay, Taupo. Phone 266 Taupo (evenings).

TAUPO BADMINTON CLUB.

THE

ANNUAL GENERAL MEETING

This Club will be held at the TAUPO SCHOOL on

MONDAY, MARCH 5.

AGENDA—

Annual Report and Balance-sheet. Election of Officers.

D. McLEOD, Hon. Secretary.

TAUPO SOCCER FANS.

DO NOT FIELD YOUR OWN TEAM?

WATCH FOR FURTHER ANNOUNCEMENT.

TAUPO DISTRICT HIGH SCHOOL

HOME & SCHOOL ASSOCIATION.

Annual General Meeting of Home and School Association will be held at the School at 8 p.m. on Friday, March 13, 1956.

Business—

Report and Balance-sheet. Election of Officers.

Constitution Question and coming Business with Ordinary Meetings.

Assembly Hall.

Letter to South Auckland Education Board re Secondary School Grounds.

Programme for 1956.

General.

Public Notices

TAUPO COUNTY.

PENALTY ON RATES.

Public Notice is hereby given, pursuant to Section 76 of the Rating Act, 1925, that an additional charge of 10% will be added to all 1955/56 Rates which remain unpaid after 6 months and 14 days from the date of demand. The last day for payment of Rates without additional charge is March 15, 1956.

After March 15, 1956, legal proceedings may be taken for the recovery of all outstanding amounts without further notice.

G. C. LAFFERTY,
County Treasurer.

PUBLIC TRUST OFFICE.

NOTICE TO CREDITORS.

Notice is hereby given that all creditors and others having claims against the undermentioned estate are required to lodge such claims at the Public Trust Office at Rotorua on or before the 4th day of April, 1956. Any claim not lodged by the date named is liable to exclusion. The claims must show full details, and must be certified as follows:—

"I hereby certify that the amount of this claim was due and owing at the date of death of the deceased."

ESTATE.

CUMMINGS, James, late of Rangitaki, Bushman, died 17/8/55.

E. MILLAR,

District Manager for Rotorua. February 24, 1956.

TAUPO BOROUGH COUNCIL.

PROPOSAL TO PURCHASE LAND BY INSTALMENT SYSTEM.

Notice is hereby given that the TAUPO BOROUGH COUNCIL has made application to the Minister of Internal Affairs pursuant to Section 165 of the Municipal Corporations Act, 1954, for approval to the payment by instalments of the purchase money for the area of land hereinafter described. The proposed purchase price thereof is £900 payable by annual instalments of £180 over a period of five years. The rate of interest to be paid on the balance of the purchase money that may for the time being be outstanding is 4½ per centum per annum.

DESCRIPTION: Lot 32, D.P. 17109, being part Section 15, Block 11, Tauhara S.D.

All persons who object to the proposal to pay the aforesaid purchase money by the instalment system are hereby notified that objections in writing to or petitions against the approval being granted must be lodged with the Minister of Internal Affairs, Wellington, within 21 days from the first publication of this notice.

Dated at TAUPO this 2nd day of MARCH, 1956.

S. TOREPE, Town Clerk.

For Sale

LUNCHEON SETS.

36-piece Sets in 6 Colours.

"Carnival"	£4/18/6
"Studio"	£4/19/9
"Myott's"	£5/5/-
"Gala"	£8/17/6

Other Designs

Wade Heath, Red & Green ..	£5/6/-
Man Friday	£5/19/6

McCLURGS LTD.
JEWELLERS

Accommodation

SOLWAY FLATS. Holiday and Permanent. Fully furnished. Fletcher St., Taupo; Phone 266 S.

TONGA CABINS.

FLATS. CABINS.

BED AND BREAKFAST.

TONGA ST.

Phone 130.

For Hire

BOATS.

CABINS.

OUTBOARDS.

FISHING TACKLE.

Acacia Bay Lodge Cabins.

Phone D. G. EWING, 312.

DON'T BUY IT - - - HIRE IT !

Gravelly Rotary Hoe. Barrows. Speedecythe Lawn Mowers. Cycles. Ladders. Chain Saws. Concrete Mixer. Saw Benches. Sewing Machines. Garden Tools. Spray Gun Outfits. Hand Saws. Vacuum Cleaners. Outboard Motors.

WALLY KILMISTER,

Roberts St., TAUPO, Phone 271.

Work Wanted

BUILDER open for work; labour or full contract. Bye, Hinemoa Ave., or Box 135, Taupo.

LAWNMOWER and Saw, Sharpening by expert saw doctor. All makes and sizes.—Leave W. L. Fulljames, Ruapehu Street.

MAKE that old Chesterfield Suite look like new with Loose Covers made from your own material. Write No. 295 Times Office.

PART-TIME work wanted by High School Girl after school and/or at week-ends. No. 296.

SECTION Clearing with Heavy Duty Rotary Hoe and Tractor. N. Kerr, Tamatea Avenue.

AFTER A DUSTY SUMMER

Get Your Floor Coverings MACHINE SHAMPOOED. It makes Carpets and Coir Matting look like new.

BUSY BEE CLEANERS

Phone 336R

For

For Sales Contn

ELEPHANTS! Little Cards' chase insect pests. Only Pharmacy Ltd.

FOR all your M Cosmetic needs sl Pharmacy Ltd.

HAIR BRUSHE range. Priced from Hansby's Pharmacy

OUR staff is a show you our sp Shoes, and you need tion to buy. Tau opposite Post Office

PLASTIC FEEL These are hygienic Only 2/6 at Hansb

SAVE every day, way, at Arbuck (opposite Fire Stat

SPECIAL Next Arbuckle's Four tangi St. (opposit White Pepper, 1/ Salmon, 2/- tin.

AT CURRIES: Embossed Nylon Azure and White; and 61/6; half new range of s Hand-bags, 24/6 season's Lullaby C 5/6 yard; best Blankets now to h pair, Pastel Che £6/19/- pair.

COAL, COKE &

ALWAYS I

A

HAINES SUE

WAIPA

FOR YOUR SPRIN

Buy

ELECTE

Price £22/17/6. A

BOOK A F

DEMONST

From D. J. McCl

LOOK INTO

COMPARE IT WI

WASHING

YOU'LL LOOK

W. L. FULLJAME

COLOUR FILM,

AND

PHOTOGRAPHIC

Availabl

TAUPO DR

Opposite F

IVORY

Economy Util

From 6 x 3 at

App

kindly providing a of a model house, of donations to the id.

of Officers

balance-sheet (see this issue) having election of officers tions had been re-

G. Potts; president, al; vice-presidents, penden, C. W. Pep- Mr G. W. Foote; . F. Fearn.

(five required): low, R. Ellis, L. F. V. T. Irvine, D. R. ce, T. G. Price, D. . Woodward, K. E. wo required): Miss ames H. Fearn, G. Irvine.

for the office of executive positions for the number reman declared the lected, amidst ap- oned that the pat- the oldest member he sense of having ership, and congrat- election, Mr Potts embers for the con- plause). Mr C. R. cted as auditor.

Barton and Mr L. appointed scrutiny- on of the commit- sulting as follows: . Barlow, L. F. W. E. Pearse, J. W. E. Young, Ladies, Mrs G. W. Foote.

anked members for r president, Mr G. ing thanks for his captain, mentioned said last year that aptain was likely to lcers, and he only he end of the year ot say, "We've had tain and now we've laughter and ap-

thanked Mr J. W. g Club captain, and ittee, for their ser- past year. (Ap-

and Annual Ball

the opening day for ldiscussed, the secre- Stretton, reporting committee recom- 7. Replying to Mr e president said the y good order. The ommendation was otion of Mr F. Bos- Mr Fearn.

of whether the an- be held there was

HARMLESS LOOKING BUT A DEADLY MENACE

The horses in the above photograph, taken on a wet morning at Waitahanui, look harmless enough. But as several traffic accidents, caused in the past twelve months or so by such straying stock on the Taupo-Turangi State Highway, have shown, they constitute a deadly menace to those travelling on the roads. That none of the accidents has yet had fatal results is something in the nature of a miracle. On Wednesday morning last week, shortly after the photograph was taken, the Taupo County authorities shot a horse straying on the road in the area, this action being in pursuance of a campaign to get rid of stock on the roads. Notice of the intention to invoke new powers given by the Impounding Act 1955 had been duly given. See report in this issue.

—Gillies Smith, photo.

some good humoured difference of opinion. Mr Cheal said the last one, owing to the counter-attraction of test football, had not "been a howling success." Mr Foote agreed, and suggested discontinuance, saying that most of them were beyond the age when —. At this point a lady's voice interjected "Rubbish!" and Mr Foote joined in the general laughter.

Mr A. L. Graham thought the ball had been a howling success. It had not been crowded, and anyway middle-aged people needed more room. (Laughter). On the motion of Mr J. D. Dance, seconded by Mr Graham, it was decided that the ball be held on a date to be fixed by the committee. Mr Gordon Sutherland suggested that the committee keep the Springbok's itinerary in front of them when fixing the date.

Subscriptions Increased

Mr J. W. Woodward, on behalf of the committee, then referred to the Club's subscription and green fees, and said that after full discussion the committee had decided that it was necessary to increase these in order to provide finance for maintaining the Club's course and amenities.

He moved, seconded by Mr L. F. W. Holdsworth, "That (a) the subscriptions for full-playing members be men £9 9s reducible to £8 8s if paid by May 1, and ladies £7 7s reducible to £6 6s if paid similarly; (b) subscriptions for country members be £4 4s reducible to £3 3s; (c) subscriptions for non-playing members be £1 1s; green fees be 5s per round, and £1 per week."

The mover said that proposed fees were estimated to produce £2348 which was £248 over the estimated expenditure. They must budget for such a surplus over maintenance, for there was plenty of use for it. With the old subscriptions they would not be able to have as good a course as they had recently enjoyed, and they must keep the course at its best.

A long and thorough discussion followed. Amendments that where married couples were members their subscriptions be £7 7s and £5 5s for husband and wife, respectively, and that green fees be 4s, were lost. It was mentioned that the proposed subscrip-

(Continued on Page 6)

JOINT COUNTY - BOROUGH ENGINEER SUGGESTED

At Monday evening's meeting of the Taupo County Advisory Committee the possibility of sharing the services of a Professional Engineer with the Borough Council was discussed. No definite recommendation was made by the County Commissioner, who was asked to go into the matter with the Council with the idea that if the Borough did proceed with the recently made proposal to appoint a Borough Engineer then the County would give serious consideration to a possible joint arrangement.

In a letter to the Town Clerk the County Commissioner has expressed his willingness to discuss the matter with the Council.

MOVE TO ESTABLISH SOCCER CLUB

An effort is being made to introduce the game of Association football to Taupo, and (as notified elsewhere in this issue of the Times) a meeting is to be held in Rickit's Tea Room at 8 p.m. on Monday next, March 12, to which all enthusiasts, both playing and non-playing, are cordially invited.

Speaking on behalf of the conveners, Mr J. L. Burge said that if sufficient interest were shown a committee would be elected and a team formed. The conveners had had experience both in playing and organising the game, and while aware of the large following that the Rugby game had throughout the country felt that there were a sufficient number of Soccer "fans" in Taupo to warrant the formation of a club.

No difficulty was anticipated in arranging matches, and the conveners were communicating with other centres.

Taupo Times 9/3/56

WEATHER REPORT

Week ending March 4: Rainfall, .82 inch. Sunshine, 38 hours. Maximum temperature, 76.2 degrees, February 27; minimum, 40.7 degrees, March 2 (Published by courtesy New Zealand Meteorological Service).

programme with two piano pieces, Mozart's Rondo Alla Turca and Debussy's Golliwogs Cakewalk, followed by Miss June Schmidt in a humorous monologue.

A sketch by J. L. Galloway, "The Dark," a tense drama of two men stormbound in a lighthouse, was effectively presented by Norman Lowe and Ron Bjorngaard, two duets being then sung by Miss June Armstrong and Mrs. A. H. McGregor, Mendelssohn's "I Would That My Boundless Love," and a Brahms lullaby, Mrs. J. M. Sherwood providing the piano accompaniments.

Sketch by Local Author

Special interest attached to the reading of a light-hearted sketch written and produced by Treve Price. Depicting the humorous tribulations incidental to the start of a holiday trip, "Getting Away" succeeded in evoking appreciative laughter from the audience and in holding the mirror up to some of the irritating, if harmless, foibles of family friends. It was a sketch that would be even more successful if produced as an acted piece rather than as a reading.

Those reading on-stage parts were Avis Acres, Grace Booth and Dot Tilley, while off-stage voices were done by Koa Sharp, Diana Young and Bob Acres.

The programme concluded with a monologue, "Kate," by Miss June Schmidt, and two piano solos by Miss June Armstrong, a Chopin waltz in C sharp minor, and Arabesque by Debussy.

During an interval Dulcie Cohen, producer, at the request of the society's president, Mr. Norman Lowe, gave some details of the first major production of the season, the three-act play "Murder Out of Tune." Those taking part will be Marie Buckleigh, Jean Dixon, Kay Howie, Elizabeth Lester, Doris McBeth, June Schmidt, Keith Christensen, John Corry and Geoff Foote.

At the close of the programme an excellent supper was served by the ladies in the supper-room.

JUNIOR AND MIDGET MARCHING TEAMS

The Taupo Crusaders Junior and Midget marching teams went to the marching competitions recently held in Tokoroa, when 11 junior teams took part. Though the Taupo girls did not come home with a prize, the committee and supporters were well pleased with their display both on the field and in the street march.

The Midgets had no competition, but gave a very able display during the day, receiving much applause from the spectators. This was the team's first visit away from their home ground.

Public Notice

THE TAUPO TIMES.
Correspondence or Enquiries should be addressed as follow:—

EDITORIAL OR ACCOUNTS—
P.O. Box 93, Taupo.
Phone 262.

ADVERTISING OR PUBLISHING—
P.O. Box 199, Taupo.
Phone 251.

TAUPO TIMES DEPOT—
C/o Mr. M. L. Svensen,
Estate Agent, Heuheu St.
ANNUAL SUBSCRIPTION—
15/- Postage Paid.

ORGANISATIONS AND ADVERTISERS—
Please note that News Copy and Display Advertising Copy for each issue should be received on the Saturday of the previous week. Classified Advertisements must be received by 5 p.m. on the Monday prior to issue.

NOTICE TO CUSTOMERS.

After a period of illness I have now resumed work. Assuring all of the best of service.

BILL DOLMAN,
Panel Beater and Car Painter.

TAUPO GOLF CLUB (Inc.)
OPENING DAY.
SATURDAY, MARCH 17.

Mixed Foursomes to start at 1.30 p.m.
Intending Members Welcome.
F. D. STRETTON, Secretary.

ASSOCIATION FOOTBALL.

All persons interested in forming a Soccer Team are invited to attend a Meeting to be held in Rickit's Supper Room at 8 p.m. on Monday, March 12.

CONVENERS—

F. HOWE, P. FRY, J. BURGE.

TAUPO BASKETBALL ASSN.

ANNUAL MEETING.

TAUPO SCHOOL.

THURSDAY, MARCH 15,
8 p.m.

All Welcome.

Clubs: Please send Delegates.

TAUPO DISTRICT HIGH SCHOOL HOME & SCHOOL ASSOCIATION.

The Annual General Meeting of the Home and School Association will be held at the School at 8 p.m. on Tuesday, March 13, 1956.

Business—

1. Report and Balance-sheet.
2. Election of Officers.
3. Constitution Question and combining Business with Ordinary Meetings.
4. Assembly Hall.
5. Letter to South Auckland Education Board re Secondary School Grounds.
6. Programme for 1956.

Public Notices

PRESBYTERIAN
SUNDAY SCHOOL PICNIC.

ACACIA BAY.

SATURDAY, MARCH 17.

THE TAUPO CRUSADERS AND MARCHING GIRLS CLUB
(Juniors and Midgets)

Wish to thank all the members of the public who assisted in making a success of their Street Display on Saturday, February, and particularly Mr. T. J. Keehan, Mr. Alec Swainson and Mrs. L. Douglas.



NEW ZEALAND LABOUR PARTY.
TAUPO BRANCH.
THE

ANNUAL GENERAL MEETING
will be held in
RICKIT'S SUPPER ROOM

at 8 p.m. on
TUESDAY, MARCH 13.

BUSINESS—

1. President's Report.
2. Balance-sheet.
3. Election of Officers.
4. General.

J. L. BURGE, Hon. Secretary.

PUBLIC TRUST OFFICE.

NOTICE TO CREDITORS.

Notice is hereby given that all creditors and others having claims against the undermentioned estate are required to lodge such claims at the Public Trust Office at Rotorua on or before the 9th day of April, 1956. Any claim not lodged by the date named is liable to exclusion. The claims must show full details, and must be certified as follows:—

"I hereby certify that the amount of this claim was due and owing at the date of death of the deceased."

ESTATE.

WAKEMAN, Marjory Isabel, late of Taupo, Widow, died 20/9/55.

E. MILLAR,

District Manager for Rotorua.
February 27, 1956.

TAUPO BOROUGH COUNCIL.

PROPOSAL TO PURCHASE LAND BY INSTALMENT SYSTEM.

Notice is hereby given that the TAUPO BOROUGH COUNCIL has made application to the Minister of Internal Affairs pursuant to Section 165 of the Municipal Corporations Act, 1954, for approval to the payment by instalments of the purchase money for the area of land hereinafter described. The proposed purchase price thereof is £900 payable by annual instalments of £180 over a period of five years. The rate of interest to be paid on the balance of the purchase money that may for the time being be outstanding is 4½ per centum per annum.

Public Notices

TAUPO
HORTICULTURAL and
BEAUTIFYING
SOCIETY.

AUTUMN SHOW.

WAR MEMORIAL HALL.
WEDNESDAY, MARCH 14.

Open—

2.30 p.m. to 5.30 p.m.
7 p.m. to 9 p.m.

ADMISSION—

AFTERNOON:

Adults 1/-. Children 6d.

EVENING:

Adults 1/-. Children 6d.

MEMBERS FREE.

DEER-STALKING AND
PIG-HUNTING on

WHARETOTO BLOCKS Nos. 6 A
and 5 B

ARE STRICTLY PROHIBITED.

P. ALFRED GRACE,
Owner No. 6 A,

And

T. ARTHUR GRACE, Chairman, and
TED BLAKE, Deputy,
Proprietors. Wharetoto 5 B (Inc.).

TENDERS.

Tenders are called for the erection of a Six-roomed House to be built in Sunset Avenue, Taupo. For plans and specifications call or telephone **R. L. Harnett, 70 M.**

For Sale

FRESH FRUIT.

APPLES—

Jonathan (ready March).

20/- per case.

Ballarat (March and April): 20/-.

Delicious (March and April): 20/-.

Golden Delicious

(March and April) 22/6.

Rome Beauty

(March and April) 20/-.

Sturmers (April and June): 20/-.

PEARS—

Winter Cole (March) 22/6.

PEACHES—

Golden Queen (March) 12/6.

Solway-Yellow Freestone 12/6.

Goodman's Choice Yellow 12/6.

Hobbs Late White

(good flavour) 12/6.

Freight Paid to Taupo.

S. HEIGHWAY, POUKAWA,

Box 313 HASTINGS.

Auctions

AUCTION.

AUCTION.

AUCTION.

24 SECTIONS

24 SECTIONS

Situated in the Manse Block, bounded by Wheretia St., Heathcote St. and Scannel St.,

WILL BE OFFERED FOR SALE

AUCTION.

AUCTION.

AUCTION.

24 SECTIONS

24 SECTIONS

For Sale

ANDY
for garden
ing up,
leather.
Men's, 11
Drug Str

AUTUMN
new sea
ever. Ta
Post Off

BABY
and Tea
for Baby
from Ha

BIGGE
stocks in
Taupo S
Office.

COSMETICS
of quality
of skins

FILMS,
Meters, I
Our inter
service.

MEN'S
Working
you decid
naturally
Shoe Sto

SAVE
way, 'at
(opposite

SPORTS
Hunter I
fishing
Only 17,
Ltd.

TOOTH
Soaps, in
personal
Pharmac

AT (
lines for
Floral V
27/11 pa
Jumpers,
Boys' \$
7/6 and
Donegal
choice r
Edgings
Nylon L
Anglais.

COAL,

HAIR

FOR YOU

**Price £2;
BO**

Public Notice

THE TAUPO TIMES.

Correspondence or Enquiries should be addressed as follows:—

TORIAL OR ACCOUNTS—
P.O. Box 93, Taupo.
Phone 262.

VERTISING OR PUBLISHING—
P.O. Box 199, Taupo.
Phone 251.

TAUPO TIMES DEPOT—
c/o Mr. M. L. Svensen,
State Agent, Heuheu St.
ANNUAL SUBSCRIPTION—
3/- Postage Paid.

EASTER HOLIDAY—
ORGANISATIONS AND
ADVERTISERS—

Please note that News Copy and Display Advertising Copy for Next Week's Issue should be received on or before Next Saturday. Classified Advertisements must be received by 12 noon on Monday.

BUS TRIP TO EDGE CUMBE.
Leaving P.O. 6.30 a.m. To-morrow, Saturday, March 24. Seats available. Phone 326, Mrs. F. Galbraith, Leaders Marching Club.

COMMUNITY ARTS SERVICE.
1956 SEASON.

varied programme of productions planned for 1956, commencing in April.

take advantage of priority bookings for these items you are asked to pay your Subscription to C.A.S. at Harmony House in Tongariro St.

NEW MEMBERS WILL BE WELCOME.

members interested in billeting of the cast of the productions asked to telephone Mrs. G. W. Sutherland, 201 S.

SOCCKER.

TAUPO UNITED A.F.C.
PRACTICE AND INSTRUCTION.
MON. MORNING, 10 a.m. to noon.
MEET
MAIN MARCHING GROUND.
Intending Players Welcome.
J. L. BURGE, Hon. Secretary.

NORTHERN CO-OPERATIVE TERMINATING BUILDING SOCIETY.

ASSETS EXCEED £10,000,000.
BEST THE NORTHERN WAY.
Plans for Children. These offer the best method to invest the Family Investment. Enquire about the Special Concessions available. Ensure your children's future now.
Share Organiser, Mr. C. G. Hilleb, will be in Taupo on March 23 and 27. Prior enquiries can be made at our **LOCAL AGENTS—**
WATSON & MOREL, HEUHEU ST., TAUPO, Phone 125.

N.Z.R. ROAD SERVICES.

Public Notices

RETURNS OF LAND.

Every person and company, whether or not a taxpayer, being the owner of land in New Zealand within the meaning of the Land and Income Tax Act, 1954, and Regulations thereunder, is hereby required to furnish on or before April 5, 1956, in the prescribed form, a return of such land as at 12 noon on March 31, 1956, where the total unimproved value, as assessed under the Valuation of Land Act, 1951, EXCEEDS £3000.

Returns are to be addressed to the District Commissioner of Taxes of the District Office of the Taxes Division of the Inland Revenue Department where the taxpayer's records are filed.

Any person failing to furnish a return of land at the prescribed time is liable to a penalty up to £100.

Return forms are available at any Post Office or from any Office of the Taxes Division, Inland Revenue Department. F. G. OBORN, Commissioner of Inland Revenue, WELLINGTON.



HARVEY, FULTON & HILL
Members Real Estate Institute of N.Z. (Inc.)

OFFER—

RESIDENTIAL AREA—

Modern 2-bedroomed House, kitchenette, dining-living-room; this house is neat and new, exterior weatherboards; interior lining of Gibraltar-board and pinex with some pine panelling; canterlever roof over verandah; large concrete terrace; attractive both inside and out, and is well priced, with view over lake and mountains, at £2800.

QUIET AREA—

A Home that has a lovely view over the lake and is very close to town; Section well cleared and fenced; exterior fibrolite and weatherboard; iron roof; a very homely dwelling, comprising 2 bedrooms, diningroom, kitchen (all electric), bathroom, all conveniences, wash-house, etc., lounge with open fireplace, garage. Price: £3200.

FAMILY HOME—

Four-bedroomed House; has a lounge, kitchen, bathroom, etc., a wet back hot water service, wash-house, electric range; weatherboard exterior; iron roof; one bedroom is detached; concrete paths well laid. Included in price are Blinds, Curtains, Linos, Frig. £2750.

For Further Information
CONSULT US FIRST
Further Details
NORMAN LOWE,
TITIRAUPENGA STREET,
Phone 160 D.

For Sale

USED CARS

Used Cars bought from BEALE HARRISON LIMITED, ROTORUA are so much better and cheaper.

- | | |
|--|----------|
| | Deposits |
| 1954 Velox, 31,000 miles, heater and seat covers. | £410 |
| 1953 Zephyr De Luxe Saloon, very nice order. | £400 |
| 1953 Humber 11 Saloon, 16,000 miles, attractive. | £375 |
| 1952 Humber Hawk De Luxe Saloon, low mileage. | £400 |
| 1952 Humber 11 Saloon, radio, one owner. | £300 |
| 1952 Austin Sommerset De Luxe Saloon, heater, radio. | £325 |
| 1952 Commer 15 cwt, also 25 cwt, both excellent condition | £300 |
| 1949 Wolseley 6/80 De Luxe Saloon, radio. | £275 |
| 1947 Chevrolet De Luxe Sedan radio etc. | £360 |
| 1939 Studebaker Sedan, very nice order. | £175 |
| 1938 Vauxhall 14 Saloon, cheap | £125 |
| 1937 Ford V-8 15 cwt, very good order. | £140 |
| 1937 Austin 7 Saloon, just had over £150 spent on it. | £75 |
| 1936 Oldsmobile Sedan, cheap and attractive. | £115 |
| 1934 Ford V-8 Coupe, first class order. | £95 |
| Special 1954 B.S.A. 350 c.c. Motor Cycle, 6000 miles, as new. | £75 |
| New Commer 15 cwt Chassis and Cab, immediate delivery. | |
- Rotorua, Putaruru, Taupo Dealers for Chrysler, Plymouth, Humber Cars, Commer and Fargo Trucks.
Phones 390, 391. Private 971.
- Our Taupo representative is Mr Ted Pearse, Phone 334 S, Taupo.

S - S - S - S - SH

Just Arrived
The Latest Super Silent Mark 6 **MERCURY**
The Rolls Royce of Outboards
See also the British Seagulls

All on Display at—
ACACIA BAY LODGE CABINS
Taupo Distributors
Phone 312

NEW STOCKS HAVE ARRIVED ! !
DRESSES, COSTUMES, COATS, SKIRTS, SUITS, etc.
Be Early and Avoid Disappointment.
A Deposit Secures for Lay-by.

AT
WEARWELLS Taupo Branch.

T. M. KENT
LICENSED LAND AGENT.
HEUHEU ST., TAUPO.
P.O. Box 155.

Phones—
Business: 94 M. Private: 94 S.

(Continue

FOOTBALL
O'Brien's Rubb
Taupo Shoe
Office.

LADIES'
from 42/6, a
opposite Post

REMEMBER
Auction; 24
Svensen, Auct

LADIES' "
8, from 39/6
opposite Post

AT CURRI
this year, ar
Season's 'Goo
Dress Flanne
Plain 13/11 y
yard; 56in Do
Basketweave
yard; 56in S
39/6 yard; L
Wear Fabrics
Warm Under
Wear all to h

KIDDIES'
Dressing Gown
STRETCH
Briefs.

LADIES' Br
Gowns in chee
TRACED I
and New Tap
FULL range
Knitting Wool
NEWMAN &
FONTAINE
TON

Shipments
NEW
See Our
On
McCl

COAL, COKE
ALWA

HAINES
W

FOR YOUR S
EL
Price £22/17/
BOOK
DEM
From D. J.

LOOK I
COMPARE I
WASH
YOU'LL L
W. L. FULLJ

COLOUR FI
PHOTOGRA
Av

**FORMATION OF TAUPO'S
FIRST
SOCCER CLUB**

Taupo's first Association football club was formed at a meeting held in Rickit's Supper Room at 8 p.m. on Monday, March 12, Mr J. L. Burge being in the chair. Conveners of the meeting were Messrs F. Howes, P. Fry and J. L. Burge. The Rotorua-Bay of Plenty Association was represented by Mr and Mrs R. C. Gill, and the Rotorua Crusaders Club by Mr E. Buckley.

The chairman outlined work carried out to date by the conveners, and the visiting representatives supplied information regarding the Association, assuring Taupo of their full support and replying to questions. It was decided that the new Club be called the "Taupo United Association Football Club," and that it affiliate with the Rotorua-Bay of Plenty Association. This comprises 12 teams, three of which are in Rotorua. Club colours are to be green shirts with white sleeves and collars, white shorts, and socks to match. The membership fee was fixed at 30s per annum.

Officers were elected as follows: President, Mr F. Howes; Vice-presidents, Messrs B. J. Baumberg, J. W. Birnle, N. Tilley and the Rev. Father J. De Bree; Secretary-Treasurer, Mr J. L. Burge; Committee, Messrs T. K. Drummond, P. Fry; Trustees, Messrs O. D. Dance, N. T. Hatton; Trainer, Mr F. Howes.

Practice and training sessions are to be held each Wednesday evening and from 10 a.m. to noon on Sundays. The first full scale practice was held on the Domain Marching Ground on Sunday, March 25, when a seven-a-side game was played. Club members have all assisted in raising funds and it has thus been possible to order all equipment required and to ensure that affiliation fees and initial travelling expenses can be paid. The Club has informed the Association that it wishes to be included in the season's fixtures, which commence on Saturday, April 14.

Indications are that the Club has made a good start, and there has been considerable assistance from persons other than those connected with the Club. The Club will welcome intending players. As some members will be working on alternate Saturdays a total of not less than 20 players is required to enable a team to be fielded. Training and all equipment, except boots, is provided and expenses are borne by the Club.

INDOOR BOWLING

There was a good attendance at the Indoor Bowling Club's evening on Monday, March 26, when the six top scores in the two sections were as follows:

LAND
a)
UPO
L 18.
RUG
R
O
LTD.
ACTORS
types of—
G.
BRADING.
DISCING.
SPA RD.,
IS
TURES.
APPLY
OFFICE.
STINGS
roprietor.
e 88.
NGTON
SOUTH.
il Goods
SERVICE
LAKE.
Reliability.
EDIES.
F
E.
IXTURES.
URES.
Guarantee

Materials - Building
**Stocks of All Building Materials and Hardware,
Gibraltar Board, Pinex Hardboard, Mouldings
Spoutings, Ridging, Roofing, Downpipe, Wire Netting,
Nails.**

FIBROLITE ASHLARS, FIBROLITE, DUROID, BUILDING PAPER, etc.

CHIMNEYS—Open Fire and Kitchen, Single or Parallel Flue.
SURROUNDS—Tile, Terrazzo or Concrete.
BOILERS—12 to 20 gallons.
WASH TUBS—Single, Two or Three Compartments.
FOUNDATION PILES. CONCRETE POSTS.
AIR VENTS. STRAINERS AND FOOTINGS.
BUILDING BLOCKS (Vibrapac). DUROCK SIDINGS.
E.W. PIPES AND FITTINGS. FIELD TILES.
CONCRETE PIPES—9in to 36in.
BRICKS—Fancy Surround, Facing, Red, Huntly Firebrick.
TILES—Flooring Red and Cream, Glazed Hearth, Glazed Floor and Wall.
GATES—Wrought Iron, Cyclone.

PREFABRICATED STEEL BUILDINGS.

W. L. FULLJAMES

RUAPEHU ST., TAUPO.

Phones: 104 S Business. 104 M Residence.

8.30 A.M. TO AUCKLAND

DAILY EXCEPT SUNDAY



Coaches leave Taupo at 8.30 a.m. for Putaruru, connecting with the service for Auckland, arriving 4 p.m.
Return services leave Auckland 9.30 a.m., arriving Taupo at 4.45 p.m.

LOCAL AGENTS FOR NEW ZEALAND NATIONAL AIRWAYS.
Full information available concerning air travel throughout New Zealand.

HAWKE'S BAY MOTOR Co., Ltd.

TONGARIRO ST.

Phone 66.

GOBLIN ACE

ELECTRIC VACUUM CLEANER

SWEEPS NEW ZEALAND.

FIRST IN 1901

AND

AFTER 50 YEARS

RUGS,
IN OIL,
MENTS,
es at the

O TIMES

6, 1956.

COMPLETES YEAR

and Wide Varied Undertaken

taupo Times over Easter the A. H. O'Keefe, made a brief of the new County administration had been drafted it would figures, said Mr O'Keefe, for political purposes the County cancelled. Rate collections have still substantial amounts on lands, some of which were sections with homes

waiting to wait a little longer expecting all the benefits that will accrue from the successful establishment of local government. With benefits came responsibilities, course, responsibilities to pay as promptly as possible, not to trespass without permits, to regulate, to keep stock off roads and

Many lessons had been learnt the past year's work, said Mr O'Keefe, and the administration might be desirable to consolidate first year's gains before starting more than urgent second year. They would long remember their first large-scale scrub fire Ruauui on New Year's Eve, with willing help of the Taupo Volunteer Brigade.

They also learnt what a great the County Advisory Committee could be to the administration especially in helping to solve problems where public opinion was important.

NEW HIGH SCHOOL APPROVED

Advice was received by Mr Board, M.P., from the Minister Education, the Hon. R. M. Algie Thursday, March 29, that he had approved the erection of blocks of five rooms each for the Taupo High School on the Wa Road site.

As reported in the Taupo Times March 16, the South Auckland Region Board had earlier approved tender for erection of High buildings and had sent the tender Wellington for Cabinet consideration.

BOWLING NOTES

Recent progress games in the Bowling Club's competitions results follow:

Colts' singles: Warbrick 24, E. Smith 13; Christensen 18, Reid 10; Reid 18, v. Warbrick 10.

Open singles: McLean 11, McBeth 15; A. Smith 24, v. McMillan 13; McBear 16, v. Smith 15; Clark 23, v. Penny 16; Pennycook 24, v. Melsaas 10.

A. Smith v. G. Fraser, by default Pennycook 20, v. Banks 19.

Handicap pairs: McMillan 19, v. Attwood and B. 9; McLean and Prosser 26, v. Bostock and Morrison 25.

Open pairs: Mahanga and Mc 19, v. McGreevy and Morris 11.

Borough Power Scheme

The Electrical Inspector, Mr. Sherwood, in a report to the Council dated March 19, stated that the erection of the new switchboard at the power house was proceeding. Eighteen consumers had been connected, bringing the total to 1378. Additional tension conductors had been run along Nukuhau Street and Runanga Street and at Nukuhau. Low tension installations had been erected in Wa Road and Rotokawa Street. The laying of the line to Hatepe had been completed and work commenced

TAUPO PLAYING AREAS

Need For Additional Grounds

A letter from Mr J. L. Burge, secretary of the newly formed Taupo Association Football Club, was before the Borough Council meeting on March 21. It explained the Club's need for the use of a ground, but said that a Taupo ground would be needed only once each four to six weeks, as many matches would be played in Rotorua, the centre of the Rotornui Bay of Plenty Association with which the Club was affiliated.

The Council also had before it a letter from Mr L. K. Bogue, thanking the Council for their confirmation of the proposed agreement for the use of the Sports Ground by the Rugby Sub-Union from mid-April to September 30, and mentioning among other matters that six senior teams had been nominated as well as four junior teams, with the possibility of a fifth junior team. The Union also asked for permission to use the two dressing rooms under the stage in the War Memorial Hall.

Sports Committee's Views

A letter from Mr F. D. Stretton, secretary of the Combined Sports Committee, under date March 21, stated that at the Committee's meeting on March 20 representatives of the various sports had been asked for their opinion regarding their requirements in 1957. Their estimates of needs for winter sports were: Rugby football, three grounds; Hockey, three grounds; Association football, one ground.

The letter stated that the only summer sports affected were Cricket and Archery, whose representatives agreed that their needs would be met by the foregoing winter sports requirements were provided and the grounds were available if required in the summer. The Committee had unanimously passed a resolution that the Borough Council be asked to take immediate steps to develop the Laughton Street Reserve, and the reserve between Kalmanawa Street, Roberts Street and Rifle Range Road.

Kindergarten Site Opposed

The letter further stated that the Committee meeting had expressed concern that a portion of the Laughton Street Reserve had been granted for use as a site for the proposed Free Kindergarten, in view of the fact that the town was short of sports grounds and that the Laughton Street and Kalmanawa Street areas were the only level pieces of ground in a central position.

The letter expressed the Committee's request that the Council find an alternative site for the Kindergarten in some area equally satisfactory for the purpose, which would not prevent the development of an area which would be ideal for many sports, particularly for the use of juniors.

The letter stated that the meeting at which the resolutions referred to were passed was representative of the bowling sports: Rugby Football, Cricket, Tennis, Hockey, Association Football, Marching and the Taupo School.

This Season's Problem

Cr C. J. Vedder suggested that as Rugby and "Soccer" were concerned, it might be possible for the Union to use the Sports Ground on Saturday mornings, rather than on separate days. Cr Swan thought that Rugby people would agree to Soccer having one Saturday in say six weeks. Cr Stanley said Saturday mornings would be impossible. The Rugby Union wanted Soccer to have the chance and when the Soccer people knew their playing dates it could be arranged.

Cr Young said that the letters received that the present Sports Ground was not sufficient. There were three sports already, Rugby, Soccer and Hockey. It would not be at present to give a long-term solution to any one sport now. Cr Currie said they should at present consider the whole question on the basis of the present season only. Hockey would

be able to use the Marching Ground this season.

The Rugby Union had a big problem this season with 12 teams possible. The main thing was to arrange for Rugby and Soccer needs this season. He suggested that a final arrangement as to use of the Sports Ground be postponed until Rugby and Soccer had had their present season's programme.

The Mayor, Mr J. E. Story, suggested that the Rugby Union should have the use of the Sports Ground this season, as in the past, with the stipulation that Soccer would have it on three or four Saturdays. Cr Vedder suggested that no agreement be made this season with either the Rugby or Soccer people, but that arrangements be made by them with the Council for their respective use of the Ground from time to time.

Cr Currie moved that the Council make an agreement with the Rugby Union for this season only for the use of a playing area on the Sports Ground, with the proviso that the Soccer Club be allocated up to four playing days, and the Hockey be allocated one playing day. The motion was seconded by Cr Stanley and carried.

Cr Currie said he wished to explain that a proposal he had made at a previous meeting, for a committee to control the use of the Sports Ground, was made with reference to this season only, and was merely that the committee suggested should represent both the Rugby Union and the Borough Council and should decide from time to time whether the Ground should be used or not on any day when the weather was wet.

Kalmanawa Street Area

Cr Vedder then moved that development of the reserve between Rifle Range Road and Kalmanawa Street be started and that it be put into grass this autumn if possible. Cr Swan seconded the motion which was carried. It was also decided that the Works Committee should inspect other areas which might be suitable for sports grounds.

Cr Young moved that the Council purchase a marking machine for use on the various sports areas, the motion being seconded by Cr Stanley and carried. On the motion of Cr Stanley, seconded by Cr Morris, it was decided that the use of the dressing rooms in the Memorial Hall be granted to the Rugby Sub-Union.

Following discussion of the matter of public conveniences at the Sports Ground, it was resolved, on the motion of Cr Vedder, seconded by Cr Stanley, that the Mayor be authorised to obtain sketch plans for such public conveniences and that a special meeting be called as soon as same were available.

In connection with the charges for use of sports grounds, it was decided, on the motion of Cr Swan, that a charge of 10 per cent. of gate takings be made for use of grounds, with a minimum charge of 10s per playing

SECTIONS OFFERED AT AUCTION

An auction sale of 23 residential sections in the old Presbyterian Church Manse property, with frontages to Kalmanawa Street, Wheretia Street and Laughton Street Extension, was held on the property on Easter Saturday, commencing at 11 a.m., the auctioneer being Mr M. L. Svensen. The sections were of approximately a quarter acre each.

About 150 people attended the sale, but very few bids were received and the sections were passed in. The reserves were announced following the auction, ranging from £670 to £690 each for five sections fronting Wheretia Street, and from £280 to £350 for sections fronting Laughton Street Extension.

Following the auction some six sections were sold by private treaty, at figures totalling some 30 per cent. of the total reserves figures. The sections sold comprised two in Wheretia Street, one in Kalmanawa Street, and three in Laughton Street Extension.

TENNIS NOTES

A combined Waitahanui and Mokal tennis team played a combined Murupara and Wairohia team at Murupara on Saturday and Sunday, March 24 and 25, the result being 25 sets all. The Mokal ladies in the combined team, Mrs J. Green, Mrs P. Hapi and Mrs Bates, played excellent tennis, winning both their singles and doubles.

K. Simon, No. 1 for Waitahanui, and Rewa Williams, No. 4, played well. P. Simon, No. 1 in the Combined team, lost two singles and won one, but won two mixed doubles and two men's doubles. Ben Rangl, a Mokal team won five and lost two fourth, won all his matches.

On the first day, the Waitahanui-Mokal team won five and last two ladies' doubles; won two and lost five men's doubles, and won two and lost four mixed doubles. On the second day, Waitahanui-Mokal won 16 and lost 14 singles.

The players for Waitahanui-Mokal were: Men, P. Simon, H. Karaitiana, B. Simon, B. Rangl, H. Thompson, P. Tahau, H. Tairi, A. Smith, K. Rota; ladies, J. Green, K. Simon, P. Hapi, M. Bates, R. Ngamotu, R. Williams, M. Hurae, A. Smith.

It was also decided that no wheeled traffic be allowed on the Sports Ground, with the exception of the ambulance when needed.

During discussion of the various matters affecting the sports grounds, the matter of the Combined Sports Committee's opinion with regard to the site granted the Free Kindergarten on the Laughton Street Reserve was mentioned. Councillors expressed the opinion that the area given the Kindergarten left ample space on the Reserve for sports purposes.

RUGBY FOOTBALL DRAW

The first round fixtures for the season's Rugby were finalised by the management committee of the Taupo Rugby Sub-Union on Tuesday, April 3, as follows:

April 14: Taupo v. Mokal, at Taupo, 2.30 p.m.; Red v. Gold (Primary), 2 p.m. April 15: Tongariro v. C.O.B., at Hिरangi, 2.30 p.m.; United a bye.

Junior games are to commence on Saturday, April 21, and any players wishing to join a team are invited to contact Mr T. Keehan, Taupo Milk Bar. Phone 77.

ROSES

and **FRUIT TREES**

Are Always in Short Supply. PLEASE ORDER EARLY.

DAVID RILEY,
HENEKURA AVENUE,
Phone 364.

COAL, COKE and CARBONETTES

ALWAYS IN STOCK.

Free delivery for orders of three bags or more.

At

HAINES' SUPERMARKET,
WAIPAHII.

FOR A WHITER WASH

AND A PERFECT FINISH—

TAUPO LAUNDRY

Our Prices Are City Prices

FOR ARTICLES

WASHED, BOILED, STERILISED,

DRIED, IRONED,

And, if necessary, STARCHED.

TAUPO LAUNDRY

RUAPEHU ST.

Phone 342 D.

TONGE'S SHOE STORE

Tuwaharetoa Street — (Opposite New Hotel) — Phone 366 M

LADIES—

"WISPY." Once more we offer you this "ROUNDBOUT" winner Black Gaberdine Casual with Patent Cross Straps 48/6. "SKIMMERS" are in again And still priced at only 36/3. New supplies of Cosy Slippers with Leather Toe Cap have arrived. Only 11/9. Our stocks and range of Fashion and Casual Shoes are huge, and this is no exaggeration. We cannot possibly display them all. Your inspection cordially invited.

CHILDREN—

A new shipment of Lace-up and T-bar Sandals has arrived—sizes from small 4 to large 5 And priced from 10/9. We have a very wide selection of English Children's Footwear, also Children's Slippers, especially imported from England. Wool Zealon School Socks by Holeproof; guaranteed to outwear three pairs of ordinary Socks. All sizes in Black Athlete Boots by "Marathon."

MEN AND BOYS—

Football Boots, as used by All Blacks, now available in all sizes. Hockey Boots by Bala are now in, in all sizes. Slippers in Leather, Felt and Camel Hair, all sizes. Boots with heel irons, all sizes. Lace-up Gum Boots and Gum Boots in sizes small 4 to large 11.

GENERAL—

Holeproof Nylons, "Queen of Hearts," with black seam and heel; also Holeproof Stretch Nylons. We also stock Silk, Lisle, etc., in all weights and shades.

OPEN SATURDAY MORNINGS.

MES

DUTIES

Who will attend the Taupo... 25, the dom... o have given... country's se... from the de... ned servicem... o fell, the occ... s.

this is fitting... by man in se... ls, the inesca... in human na... o do and to... s Dr Johnson... n they need...

ons as Anzac... for us. Res... ers or sisters... And rememb... of willingne... hat, more pr... e of the ever... y work and se... ight to our o... honour our... es of them ac... re steadfastly...

to recall the... rvicemen and... open to us... o provide for... some help that... rved as Poppy... sale of poppie... vell known, the... onvisible admin... rvices Associat... by our thought... ssion in the op... help some of...

BLE COMMENT ORTS GROUN

orts Ground, con... the close of the... n on the Tor... and used on Sa... rst time, was th... favourable comm... l spectators. The... lf already has... grasses and clove... as expressed by... t another spring... vth, with the irr... talled, should re... lass sward.

RUGBY SEASON OPENED

Taupo Defeats Tuaropaki

Taupo's recently formed sports and, excavated and sown down in following the 1954 season, was for the first time on Saturday, April 14, when a curtain-raiser was played between Rotorua High School Old Boys and the United Club's (Taupo) fifteen. This was followed by a short game between two Taupo primary school teams, the Red and the Gold, won by the latter, and soon after three p.m. the first game in the Taupo Rugby Sub-Union's 1956 competition began, the Taupo Club's fifteen meeting the new Tuaropaki club (Mokai).

When the two latter teams lined up on the field they were met by Mr J. Stanley, president of the Rugby Sub-Union, and Miss Keren Reid. Miss Reid was the Maori Queen candidate, the winning candidate, in the recent Carnival held to raise funds for the construction of the Sports Ground, and had been invited to open the Union's 1956 season by "kicking in" in the first competition game. This she did after Mr Stanley had welcomed the teams to the new ground, and had expressed the pleasure felt by the Union in having Mokai, as represented by the Tuaropaki club, again playing in the Taupo Union's competition.

The curtain-raiser was won by the Rotorua H.S. Old Boys team, 15-nil, tries being scored by Lewis (1), Webster (2) and David (1), and a penalty goal kicked by Berg. Mr R. Dixon was referee.

Taupo Defeats Tuaropaki

Teams in the first competition game, won by Taupo, were:

Tuaropaki: H. Green, S. Roha, R. Seymour, T. Rota, R. Roha, G. Roha, I. Smith, M. Andrews, Ginger Kapua, J. Adams, D. Graham, H. Tatana, W. Roha, F. Hiko, D. McFadgen, F. Rivers and reserve, R. Kaio.

Taupo: T. Waldron, Erickson, Robert Grace, Hamilton, B. Garlick, Panapa, A. Crowther, F. Reid, Thomas, R. George, G. Vedder, Smith, Tito, Woodward and Knight. Shortly before time Grace retired hurt and was replaced by N. Thimbleby.

During the first quarter-hour's play Tuaropaki mostly had the territorial advantage, and nine minutes after the start Taupo were compelled to force down. Soon after, a fine line kick by Crowther from behind the Taupo scrum took play halfway to the visitors' twenty-five. From the throw-in Taupo initiated a passing movement. When the ball came to Grace, the centre threequarter, his forceful straight dash of about 30 yards showed up to great advantage against the cross-field tendency previously shown by the backs.

The first score came 17 minutes from the start, Mokai, in Taupo's twenty-five again, being awarded a

TAUPO SOCCER TEAM SHOWS PROMISE

The Rotorua Soccer competition opened at the Kuirau Reserve, Rotorua, on Saturday, April 14, with four senior teams, one of these being the recently formed Taupo United Club's eleven, which gives promise of being a team to be reckoned with. The Taupo eleven met Whakatane Town, the latter winning 4-3.

Taupo, which will be able to call upon about 30 players during the season, was not able to muster its full strength on Saturday because it was a working day for most of the geothermal project workers, but it put up two quick goals against Whakatane Town, which, on paper, appeared a strong side. Lack of knowledge of one another's play, however, was evident from the outset, and Whakatane, getting into its stride, ran up four goals in a row.

Taupo had the last word, however, and the game ended 4-3. There is a judicious balance of youth and experience in both these XI's, and after a few more games, their real strength will be more apparent. Scorers for Whakatane Town were A. Brooks (2), A. Kirk and F. de Reuter, and for Taupo, A. Millar (2), and W. Harding, junr. The referee was Mr Bolt.

The teams were:

Taupo United: J. Howes, R. Girling, W. Harding, senr., J. Braddock, T. Drummond, J. Smith, G. McKean, P. Fry, W. Harding, junr., R. Braddock and A. Millar.

Whakatane Town: J. Bylisma A. Kirk, G. Mercer, I. Learmod, C. Douglas, J. Carey, A. Brookes P. Griffith, F. de Reuter, N. Neiderer, W. Christie.

time Grace received a knock on the side of the head and had to go off, being replaced by N. Thimbleby.

Both teams were now showing signs of tiredness and the game became somewhat ragged, though there were flashes of better play from time to time. Garlick broke away with the ball near the halfway, sold a dummy at the twenty-five and went on to score. Taupo 19, Mokai 8.

A little later Franklin Reid got away in possession and after several had handled the ball it fell to Thimbleby to add another try, which Tito converted. Taupo's tally of 24 was increased shortly after to a final 27 by a good try, when Barry Thomas got possession from a ruck and could not be caught.

Though both teams showed signs of not being in first-class condition, some promising work was seen. The Mokai men were better than the score indicated, and there was evidence of penetrative power in their backs that only needed a little better combination to become effective. Mr Kori

"THE CHILDREN'S CLOTHES FOR H GIRLS' JEAN CHENILLE JUMPERS—

NEW STOCKS OF V BRUSH WOOL WAISTE WOOL AND J N FI BRUSH AND N WO WOOL JERSE HOUSE

B. CC

Near Hawke's TONGARI

THREE WAYS T

Heat Your F

FIREMASTER—The Continuous-bu

The MACKAY Space Heater—/

Plan your home around a / live all the year round in a

POMEROY

Super Safe Electric Radiator

ODLIN'

TAUPO BRANCH

Representative— P. STAINES.

Here they

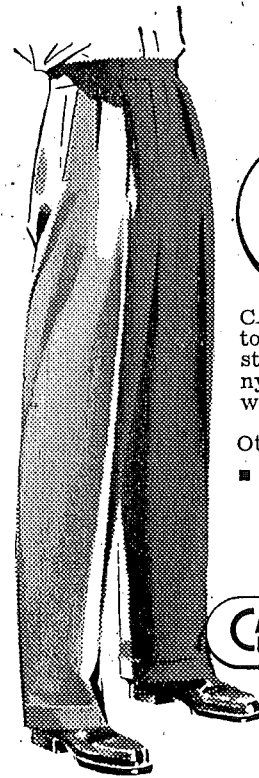

THE IN

CAM

CAMBRIDG top-line fe styling, co nylon-rein waistband,

Other Top

ALL ST Self Be Waist, or Belt

CAMBRIDG CLOTHES FOR

PRICED FRC

DICK

THE MEN'S SH

must have seemed an eternity. There was no guarantee that even food would be supplied them, far less water or ammunition. During those months no less than 30,000 men were killed, and a further 80,000 were wounded or taken prisoner.

"Gallipoli however, was only one campaign wherein the Anzacs fought. Many and varied were the roles they played throughout the First World War, only to find their sons fighting another world war a short 21 years later.

Our Moral Inheritance

"We, as New Zealanders, were, and still are proud to find in the second generation those same qualities of esprit-de-corps, grim courage, and tough endurance that had so distinguished their fathers. From the start of World War II in 1939 the Anzacs were to the front, on land, on sea, or in the air. Chief Petty Officer Mason Riseborough, here to-day, was serving in H.M.S. Achilles in the Battle of the River Plate, one name which will be known in history for many years to come. All through Greece, Crete, the Middle East, the Far East, and the Pacific, in all the theatres, the Anzacs played their part. I think there can be nowhere in the world where that name is not known and revered.

Homage to Sacrifice

"With World War II not much more than a decade past, and the Korean War still a very vivid memory, it is only right that we should dwell a moment and pay homage to those who paid the supreme sacrifice. There must be hardly a town or hamlet in New Zealand to-day wherein someone is not mourning the loss of a son, husband, or father. It is to those people we offer our heartfelt sympathies. I do hope that they realise how proud we are to remember them as Anzacs.

Carrying the Torch

"Before concluding, I would like to give a thought to your Returned Services' Association here. From what I have seen of you, I can perhaps liken this branch to what we sailors call 'a happy ship'. There is present an indefinable thread of loyalty both to the Association and to your fellow-members. It is in your hands to see that it is never placed in jeopardy. I think many of you will agree that true comradeship was unknown to us until we joined the Services. During that time in the Services that com-

served. On the sounding of another bugle call, "The Reveille," the flag was slowly hoisted to the top again.

Wreaths were then placed at the foot of the flagstaff from the Taupo Borough Council (placed by the Mayor), the Taupo R.S.A., other organisations, next-of-kin and citizens.

At this stage the Mayor laid on the table for inspection the crest of H.M.N.Z.S. Taupo formally handed over to him by Lt.-Commander Hale at the R.S.A reunion on Anzac Eve.

The service concluded with the singing of the hymn "Abide With Me," after which refreshments were dispensed in the R.S.A. room in the Memorial Hall.

The Parade

There was quite a fair muster for the parade of Services preceding the Commemoration. Represented in the assembly at Taupo School and the march to the Memorial Hall were the Taupo branch of the R.S.A., under the president, Flight-Sergeant H. B. Pickard; Legion of Frontiersmen (Frontiersman P. Warbrick); Taupo Fire Brigade (Chief Fire Officer Douglas); Taupo School Cadets (Corporal Dixon). The muster was under the command of Lieutenant C. S. Currie.

At St. Patrick's Church

The Catholic commemoration observance of Anzac Day was a Requiem Mass, celebrated at St. Patrick's Church at 8 a.m., conducted by the Rev. Father de Bree.

ASSOCIATION FOOTBALL

The Taupo Association Football Club played the Caledonians on the Kuirau Reserve, Rotorua, on Saturday and in a fast hard game they were eventually beaten by 5 goals to nil. The match was not so one sided as the score would suggest.

At the commencement there was little between the two sides. Five minutes before half-time, only one goal had been scored. Up to that stage the Taupo defence was strong, but their forwards failed to make use of several opportunities.

Rotorua commentators believe that if the Taupo team could be fielded regularly at full strength and could develop an understanding of one another's play they would settle down into a formidable side.

Tomorrow the Club hopes to be able to take a strong side to Rotorua to play Kawerau.

Taupo Times 4/5/56

were made by His Worship.

Apologies for absence were received from the Rev. H. Tongohau, Mr. W. R. Morris and Mr. J. Sherwood.

HATEPE NEWS

Easter holiday at Hatepe was one of the brightest in memory. Good weather and an abundance of trout in good condition kept the anglers busy and contented.

Fish weighing 9½lb were caught by W. Forsyth and M. J. Krivan, of Palmerston North. A nice rainbow trout weighing 9½lb was caught at the Rip by Mr B. Prior, of Auckland.

Our community was grieved to learn of the passing of Archdeacon A. Hall, who for some years past spent his holidays at Hatepe. His kindly nature and quiet humour endeared him to a wide circle of lake visitors. The late Archdeacon, with Mrs Hall, occupied a local cottage in February, when his health was failing. His death at Eastertide came as a shock.

Mr D. McKenzie, who was severely burned at Hatepe, has been transferred to Middlemore Hospital, for skin grafting, after being in a critical condition at Rotorua Hospital for some weeks.

Workmen are busy erecting power poles in the Hatepe Settlement, and it should not be long before the district is lit by electricity.

With the recent unsettled weather, fishing has become patchy. The river is rising and the mouth has changed, forming a new wide rip.

RUGBY GROUND COURTESY

Players and Patrons are requested to use the gate or the stile and not climb over the fences which will not stand the strain.

Spectators and players are requested to use the town side embankment on the Sports Ground and not move across to the western sideline, nor to move on to the field at half-time. This is the prerogative of the players, referee, coaches and managers ONLY.

If you want to make an easy job seem mighty hard, just keep putting off doing it.

RE-DECORATING?

WALLPAPERS—We have a large stock.

MONOCOAT—The Flat Paint that's so easy to use. Goes further, scrubs better and lasts longer. 26 shades.

ENAMELS AND VARNISHES—

NATIONAL LEVELOR VENETIAN BLINDS.

CATO'S COLOUR CENTRE

THE PAINT AND WALLPAPER SPECIALISTS.

Telephone 238 D— or after hours, 379 W.

ROBERTS STREET (just around the corner from the Main Street).

OPTICIAN

T. A. McCLELLAND
F.S.M.C. (London)

NEXT VISIT TAUPO
ON
WEDNESDAY, MAY 23.

Appointments Ring

MR. G. FRASER
CHEMIST—TAUPO

FOR

SIGNS,
DISPLAYS,
PAINTING and
DECORATING—

KAYDET KRAFT
(H. D. KING)

Box Messages:
Mercer's Drapery,
Phone 248 S.

J. S. BURROWS LTD.

BULLDOZING CONTRACTORS

Specialise in All Types of—
EARTH MOVING.
ROAD GRADING.
ROAD CLEARING.
GIANT DISCING.

TAUPO DEPOT—
H. AMUNDSEN, SPA RD.,
Phone 270.

QUALITY MEATS

From
HAWKE'S BAY PASTURES.

TAUPO MEAT SUPPLY

E. T. SMITH.
OPPOSITE THE POST OFFICE.
Phone 27.

TAUPO—NAPIER—HASTINGS
TRANSPORT.

T. LEADBETTER, Proprietor.

TAUPO DEPOT—
ROBERTS ST. Phone 88.

DAILY SERVICES
CONNECTING WELLINGTON
AND ALL TOWNS SOUTH.

Local General Goods
Carrier.

REGULAR FREIGHT SERVICE
AROUND THE LAKE.

Service Built On Reliability.
Phone 88.

BE PREPARED FOR WINTER.
Stocks of
VERITAS, VALOR and LEO HEATERS.

SOCCER

Taupo Club Now Organised

The Taupo United Football Association Club has now been fully organised for administration. Officers are as follows:

Patron: Mr A. Kennedy.
President: Mr F. Howes.
Vice-Presidents: Rev. Father J. De Bree, Dr D. Richards, Mr J. M. Birnie, Mr B. Baumberg, Mr N. Tilley.

Secretary-Treasurer: Mr J. L. Burge.
Committee. Messrs P. Fry, T. K. Drummond.

Trustees. Messrs F. Howes, N. T. Halton.

Club coach: Mr F. Howes.
Team captain: Mr S. Kempton.
Kempton.

Vice-Captain: Mr T. K. Drummond.
Mr W. Harding has been appointed a Rotorua and Bay of Plenty referee. The team is now completely outfitted with the required sporting equipment.

Playing Area Problem

The lack of a suitable playing area is the only real problem at the moment. It has not been found practical to make use of the Domain sports ground as this would mean removing the Rugby Union's posts which are a permanent fixture and marking in additional lines which would prove to be a hindrance to the Union. Efforts are being made to obtain the use of another area for the present season in the expectation that the Borough Council will be able to make available a ground for the following season.

A total of 17 players have signed on for the club and a number of others will be available, duties (and wives) permitting. More players are required due to a number of the present members being required to work on various Saturdays.

Prospective players wishing to join the team are invited to attend the 10 a.m. Sunday practices on the school ground.

Gradual improvements are being made in the various team positions and members feel that they will shortly be chalking up their first win. Although every effort is being made to field the strongest possible team all playing members will be assured of a number of games during the season.

It is expected that a number of competition matches will be played in Taupo in the near future.

Team Visits Rotorua

A strong Taupo team visited Rotorua on Saturday, determined to return with their first win of the season under their belt. They did but it was empty win, for their opponents, Kawerau, did not turn up and apparently failed to notify the authorities of the fact that they were not putting in an appearance. Result: Two points to Taupo for a win by default and the return of a disappointed Taupo team after travelling 104 miles without playing a match.

T. T. 1115/56

Every child comes into the world endowed with liberty, opportunity

Materials - Building

Stocks of All Building Material
Gibraltar Board, Pinex Hard Spoutings, Ridging, Roofing, Doveling, Nails.

FIBROLITE ASHLARS, FIBROLITE, PAPER, etc.

CHIMNEYS—Open Fire and Kitchen, S
SURROUNDS—Tile, Terrazzo or Concrete.
BOILERS—12 to 20 gallons.
WASH TUBS—Single, Two or Three Com
FOUNDATION FILES. CONCR
AIR VENTS. STRAI
BUILDING BLOCKS (Vibrapac).
E.W. PIPES AND FITTINGS.
CONCRETE PIPES—9in to 36in.
BRICKS—Fancy Surround, Facing, Red, H
TILES—Flooring Red and Cream, Glazed E
Wall.
GATES—Wrought Iron, Cycloane.

PREFABRICATED STEEL B

W. L. FULLJA

RUAPEHU ST., TAUPO

Phones: 104 S Business. 104 M

8.30 A.M. TO AUCKLAND

DAILY EXCEPT SUNDAY



Coaches leave Taupo at 8.30 a.m. for Pu
the service for Auckland, arriv
Return services leave Auckland 9.30 a.m.
4.45 p.m.

LOCAL AGENTS FOR NEW ZEALAND
Full information available concerning
New Zealand.

HAWKE'S BAY MOTOR

TONGARIRO ST.

Phone 66.

FIRTH



Leads the field in portable concrete prod

A. VOSS
ELECTRICAL CONTRACTOR
OPPOSITE TAUPO AUTO DEPOT
Phone 306 D.
Alterations, Additions,
and Repairs.
Satisfaction Guaranteed

CLARKE'S
SOFT DRINKS & CO.

NOW OBTAINABLE FROM
OUR DEPOT—
PIHANGA ST., TAUPO
Phone 280 S

PAINTING
INTERIOR AND EXTERIOR
DECORATING
Decorate Your Home, Shop or Office
Expertly Decorated

DRUMMOND & CO.
Estimates Free. Moderate Charges.
INEMOA AVENUE, TAUPO
Phone 264 K.

TAUPO TRANSPORT

For All Classes of
BULLDOZER WORK
Roadmaking. Drives
Excavating.
SECTION CLEARING
with minimum of top
removed.

Quotes or Personal Inspection
Ring

ROGER HARNETT
(70 M)
Also
Used General Goods Carrier



FRYE, FULTON & CO.

Members Real Estate Institute
N.Z. (Inc.)

OFFER—

7 compact 2-bedroomed Cottage,
kitchenette, septic tank,
house, shower, all electric,
to township. Price: £2850.
POST-NEW 2-bedroomed
good locality, large lawn,
en, wash-house, bath,
herboard, fuel range and
Section cleared and ready to build.
: £2100.
R school; 3-bedroomed house,
lounge, kitchen, bath,
house, all electric, well

SOCCER AT ROTORUA

Taupo United met Rotorua Crusaders at the Kuirau Reserve, Rotorua, on Saturday, May 12, in a friendly fixture.

The match gave both teams the opportunity to give new members and junior club players a trial. Despite new faces in both teams good keen football was displayed, and from the kick-off the Taupo defence was put to the test. Lack of first time tackling was evident, giving Crusaders' forwards plenty of time to try out their shooting skill.

By half-time Taupo were three goals down, without their forwards even looking like scoring. The Taupo coach took advantage of the interval to give a pep talk on tactics and positional play. This had pleasing results, with Taupo taking the offensive in the second half.

Taupo was soon rewarded with a goal and full honours must go to the Crusaders' defence that no further score came from the Taupo forwards. Play was still very even, but Crusaders, after several near misses, found the net once again to make the final score 4-1.

For the Taupo side, W. Matthews, at fullback, was a steadying influence in defence, with R. Gilling, at half-back, feeding the lively right wing at every opportunity.

The referee, Mr. W. Harding, of Taupo, was to be congratulated on his excellent handling of the game, and will be a most welcome addition to the Association.—Own Correspondent.

Another Business Opens

Messrs Currie's Drapery, Ltd., this week re-opened the Roberts Street premises, occupied by them prior to their moving into larger premises in Rickit's Buildings, as a furnishing store. The new business will specialise in floor coverings, curtains, drapes, blinds, nursery furniture and soft furnishings generally. Mr Garth Marsland will be in charge of the shop.

Manufacture of fertilisers out of sawdust and other sawmill waste using a bacterial process developed by Earp Laboratories, Hampton, U.S.A., is being undertaken by a new firm in Pendleton, Oregon. The new firm is the Organic-Pacific Company. The process is dependent on a special type of bacterium which does in less than 36 hours what nature's ordinary bacteria take over six months to accomplish, the decomposition of organic matter which gives top-soil its ingredients of nitrogen, calcium, phosphates, potash and minerals.

NOW is the Time to Select Your WOOLLENS.
DICK FRASER
 SUGGESTS—
UNDERWEAR.

LAKE FRONT GARAGE LTD.

Phone 97. Phone 97.
SERVICE STATION AND GARAGE

B.P. PETROL AND OIL.
ENERGOL GREASING SERVICE.

24-hour Breakdown Service.

BOATS FOR HIRE.

Taupo Agent for—

SEAGULL OUTBOARD MOTORS.

HARCO GAS LIDGARDS FIBRE GLASS
 B.P. COMPROX COVERED BOATS
 HOUSEHOLD DETERGENT

SPRINGBOKS v. WAIKATO

AT HAMILTON.

SATURDAY 9th JUNE.

SPECIAL EXCURSION

Our Service Coach will leave Taupo at 7 a.m. direct for the Park, returning after the game.

RETURN FARE FROM TAUPO 30/-

RETURN FARE FROM TAUPO 30/-

Book Early At

HAWKE'S BAY MOTOR Co., Ltd.

TONGARIRO ST.

Phone 66.

CONCRETE EVIDENCE

of perfection
 is shown in this
 reinforced pumice chimney
 ready for erection.
 Available at once
 from your local dealer.
 This is one of many
 different models designed
 to suit every possible site
 and purpose.
 Examine the evidence yourself.

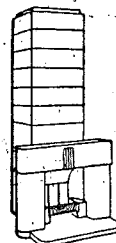

**FIRTH
 CONCRETE
 LTD**

O FURNITURE MART

OA ST. Phone 101 S.

IE COLD WEATHER APPROACHES

SEE OUR STOCKS OF—

BLANKETS.

MATTRESSES—

WOOL. RUBBER. INNERSPRUNG.

COLUMBUS RADIOS.

DE CHAIRS. SPARK GUARDS.

OCCASIONAL FLOOR RUGS.

TS. GOOD SELECTION OF LINOS.

All Qualities.

TIMBER

FOR RETAIL SALES OF—

AI. BEECH. PINUS. WHITE PINE.

NALISED (TREATED) TIMBER.

PINUS AND WHITE PINE.

TIMBER.

HIGH-CLASS JOINERY.

FLUSH DOORS.

A TIMBER and JOINERY Co., Ltd.

Associated with
OS. LTD.—Native and Pinus Sawmillers.
Motor and General Engineers.

OAD (Off Spa Road) — — — TAUPU.

NEW MODEL FORDS

CONSUL PREFECT ANGLIA

soon under No Remittance Licences.
Overseas Funds should contact us now.
elp to obtain your licence.

ERSBY MOTORS LTD.

FORD DEALERS, ROTORUA.

AMERICAN FURNISHING PRINT.

f—Colourful Designs in Novelty and Floral.

From 7/6 to 15/- per yard.

UA FURNISHING CO.

ROTORUA

mes 52 and 88. P.O. Box 484.

LEC MCGREGOR

LAN KOHA ROAD

P. O. BOX 150

power station would make available, being put into the national system. Taupo's need for extra power is pressing, and suggest that reliance on the national power system should be the place of normal development of the local scheme show lack of appreciation of the position, not only of Taupo, but the country as a whole.

The time has surely come when local authorities should be encouraged to develop to the full all power schemes that be shown, as has the Taupo one, to be economically sound. Even such scheme in being will lighten the burden on an already overloaded State system. The present suggestion from Wellington indicates that, despite protests that electrical authorities all over the country have made in recent years in regard to electrical power position, there still apparently exists in Wellington an unwillingness to see local authorities developing their own electrical resources. It can be granted that difficulties exist in the loan money field at present, but that does not mean that loan moneys cannot be obtained.

It can be shown that power can be generated at less cost at the proposed local power station than it can be supplied from the national grid; power generated locally would provide a surplus plus for the national grid, and would save a substantial amount of tonnage of coal being burned in the Meremere coal burning station; the General Manager of the Hydro Electric Department has admitted that there is no objection on technical grounds to the issue of a water power licence for the scheme; and the economic merits of the proposal are unassailable.

In view of Taupo's growing need, and of the whole country's electric power demands, it is inconceivable that any delay in carrying out the project should be seriously suggested or acquiesced in. It is hoped that the Council's further representations in Wellington will lead to a re-assessment of the position by the powers that be. There has already been too much delay in Wellington in dealing with Taupo's application for authority to go ahead with its plans.

C.W.I. MEETING

There were 24 members present at the monthly meeting of the Taupo Countrywomen's Institute, at which Mrs G. Davis presided in the absence of the president, Mrs W. King. The motto was, "Life without friends would be like a garden without flowers." The roll call was on the subject, "What we like and dislike in our meetings."

A birthday spray was presented to Mrs J. D. McLeod. The Golden Thought, read by Mrs F. Bostock, was from the "Home and Country" editorial "Take Time." Mr Andrews, member of the Waikato Hospital Board for Taupo, gave an interesting talk on various hospitals in the Waikato, and spoke of the extension to be built to the Taupo Maternity Hospital. He stressed the need for a cottage hospital in Taupo, and also praised the work of the Taupo St. John Ambulance Brigade. Mrs Davis thanked Mr Andrews for his address. Competitions resulted as follows:

Arrangement of leaves and berries, Mrs Stowe 1, Miss McClymont 2; best bloom, Mrs Stowe 1, Mrs Glass 2; cluster, Mrs Gumbley 1, Mrs J. D. McLeod 2; vegetables, Mrs Noble 1 and 2.

Ten Pound Rainbow

Mr Greg Collett, of the Taupo Telephone Exchange staff, fly-fishing at the week-end at the mouth of Waitotaka River, took a 10lb rainbow. The fish was in splendid condition, and its proud captor intends having it mounted.

SOCCER NOTES.

Taupo United met Rotorua Crusaders (whom they had met in a friendly game the previous week) at Rotorua on Saturday, May 19. Crusaders again winning by four goals to two. Both teams were at full strength. Taupo started off in fine style and scored the first goal, netted by Drummond.

The home team then turned out their best brand of football. They stood up to the onslaught and thanks to some wonderful saves by the goalkeeper, Alkema, the half-time score was kept to 2-1. The second half started with no let-up but either three Taupo players began to show the strain and Crusaders netted two more from breakaway shots.

Taupo meet Rotorua Rangers next week-end.

Taupo Times 25/5/56

FIRST BADMINTON MATCH

The following players have been selected to represent the Taupo Badminton Club in a match against the Hamilton Club tomorrow:

Messrs K. Neill, T. Waldron, Stewart, N. Hatton, P. Staines, McGreevy, Mesdames G. Davies, Philpott, M. Douglass, E. Collins, Staines and Miss M. Hirst. Reserve N. Williams and Miss B. Bolton. The matches will take place at the War Memorial Hall commencing about 7 p.m.

or 18,000 acres
o enquire to

VENSEN

AUCTIONEERS.

s—
fice.

298 W.K.F.
f Links Road.
ruanui Street.

KENT

ID AGENT.

TAUPO.
155.

Private: 94 S.
7, 94 D.
36 D.

to do with
s interesting to
to be eased on
er £6000, and
ary Commission-
lding should be
ity of builders
confused.

1 weather, we
ankful for—no
ver, full water
in mind: The
hen conditions
ather or econ-
n't wait until
of an election
d uncontrolled
roperty.

is, big living-
fireplace that
kitchen with
bench, range
oom, detached
y useful, and

3; about 1-3rd
tage to main-
a zoned in-
aks for itself.
see a service
sperous shops
the owner
ents. I'll be
u so."

only people
want to buy
oung people
any capital.
see it, or
ity suffering
ent myopia?
it to the

ltable for a
poses, apart
five it some

3 more than
3-bedroomed

E,
AGENT.

1971 has risen by 2028 to the 1956
ensus total of 9599, an increase of a
ttle more than 26.7 per cent.

Some Comparisons

It is interesting to note, compar-
g Taupo's population, and its rate
increase since last census, with
ose of other South Auckland towns,
at the population of Morrinsville in
1951, according to the census figures,
as exactly the same as Taupo's
esent population, 2824.

While Morrinsville's population has
eased between 1951 and 1956 by
25, an increase of 25.6 per cent,
however, Taupo's increase of 1,484
epresents a per centage increase
ver 1951 figures of 109.27 per cent.

The percentage increase in Te
Awamutu has been 18.6 per cent, the
1956 total being 4600, an increase of
22. Otorohanga, with 1917 people
n 1956, shows an increase of 348, or
22.1 per cent. Matamata, with a
1956 total of 2,692, shows an increase
of 565, or 26.5 per cent. Putaruru's
rate of increase has been higher, be-
ing 50.4 per cent, its 1956 total being
3617 compared with 1872 in 1951.

SOCCER NOTES

Taupo United kept their reputation
of providing stiff opposition when
they were defeated six goals to three
against Rotorua Rangers at Rotorua
last Saturday.

Taupo started off in fine style and
the scoring was opened by G. Doyle
for Taupo with a good high shot. Be-
fore the Rangers' defence had settled
down, W. Marriat, a welcome new-
comer to the Taupo team, beat the
keeper with a well-timed shot.

The Rangers' forwards began to
find their form and took advantage
of poor positional play by the Taupo
defence to score three goals in suc-
cession. Taupo fought back and G.
Drummond equalised, bringing the
half-time score to 3—3.

The second half started off with
good football displayed by both teams
but after Rangers found the net for
the coveted lead, Taupo was guilty of
playing a defensive game, with no
one to start off an attack.

Rangers added two more goals to
their score, one from the penalty spot,
to finish off a good, hard match.

Taupo Times 1/6/56 Sealing of Story Lane

The first coat of sealing on Story
Lane, for its full width between the
Memorial Hall and the Post Office,
from Tongariro Street to a point near
the Police Station entrance, has been
completed. In addition, the area be-
tween the Memorial Hall and the
Police Station, being used as a tem-
porary basketball ground and plan-
ned for later use as a parking area,
has also been sealed. The area sealed
equalled threequarters of a mile of
road at a width of 20 feet. The pre-
paration work was done by the Bor-
ough staff and the sealing applied by
a Rotorua firm.

usual role of halfback. Taupo con-
sistently attacked for some time dur-
ing the second half and staged some
passing rushes from which first
Erickson, and then Grace, went very
close to scoring. Vedder was also
nearly over from a forward rush.

Mokai, however, then started to
assert themselves and mainly per-
medium of forward rushes gave Tau-
po some anxious moments. With only
a few minutes to go Mokai scored an
unusual try. A scrum went down
right on the Taupo goal-line and when
their forwards hooked the ball back
over the line halfback Crowther, in-
stead of forcing, elected to kick for
touch. The kick flew low and hard,
straight into the arms of Kaio stand-
ing on the goal-line and he had only
to put the ball down to score. An-
drews goaled to level the scores
again.

Both teams went flat out for the
final five minutes, and Grace, for
Taupo, caused a thrill when from a
long range penalty he missed by the
narrowest of margins. The game fin-
ished with a race for the ball over
the Taupo line, in which Waldron
beat Kapua to kick the ball dead.

Credit must be given to the Mokai
forwards for the manner in which
they stuck to their task to the end,
and to Kapua in particular. When
he switched to the forwards he was
a tower of strength, being particu-
larly destructive in his lineout work.
Andrews, when he reverted to half-
back, played his usual sound game,
and Seymour, though not so conspi-
cuous as usual with his spectacular
dashes, was very useful with his safe
display.

For Taupo, Vedder was outstanding
in the forwards, ably assisted by
George McCauley and Thomas Crow-
ther gave his usual plucky display at
halfback, though handicapped by the
slow service from the scrum and the
harassing work of the fast breaking
Mokai forwards. Balmforth got
through a lot of good work on attack
and defence, and Waldron was cool
and accurate with his line kicking.—
Own Correspondent.

Tongariro-C.O.B. 6-all

For the senior game against College
Old Boys, played at Hirangi, Tonga-
riro were a much improved team. The
result was a draw, six-all, Old Boys
points coming from two unconverted
tries, while Tongariro had one try
and a penalty goal.

Effective bustling tactics by the
Tongariro forwards proved too much
for the C.O.B. backs, who made every
effort to open up play. Mishandling of
the greasy ball, however, allowed
Tongariro to dominate loose play.
Old Boys' captain, G. Kopu, played
his usual good all round game and
dominated the lineouts at will. He
scored a typical Kopu try, Downs
scoring Old Boys' second try. For
Tongariro, J. Rawhiti scored a try,
and a goal was kicked from a penalty
by J. Munro.—Own Correspondent.

drome on account of fog, his luck
running low and he decided to
a forced landing in the Don
sports ground. There were ho
at the north end of the ground, pe
about in the street, electric pc
lines at the north end of the gro
and trees to the south. There
no fog.

Detective Austin in evidence
he had interviewed defendant
Palmerston North. Defendant
admitted that he had landed o
topdressing strip near Oruanui f
to coming on to Taupo and had ta
off again. He had stated that
got out of the plane and walked
ward the house but could see
lights and no one about so he de
ed to fly to Taupo. He admitte
was then getting dark but said it
not dark.

Sunset was at 6.16 p.m. and
latest defendant could have flown
that day was 6.41 p.m.

Defendant in evidence said he
anxious to reach a telephone to
the authorities of his whereabouts.
He submitted that it was not
dangerous flying to land as he did.
understood that the plane was fl
off again the following day, an
was generally considered less
dangerous to land a plane in similar
cumstances than to take it off.
was not dangerous flying to take
plane off how could it be dange
to land it.

His Worship commented that
plane had been taken off by an
perienced pilot. Defendant had
no business to take off again f
Oruanui. The penalty provided w
fine not exceeding £500 or impr
ment not exceeding 12 months, sl
ing that the legislature regarded
offence as serious. He felt he c
not impose a fine of less than
tenth of the maximum. Defen
would be convicted and fined
with Court costs £1.

Defendant was given time to
payment to be at the rate of £2
week.

PUBLIC TELEPHONE A A.C. BATHS

In November last, the Bor
Council made a request to the
and Telegraph Department for
installation of a public telephon
the A.C. Baths.

In a reply received recently
the Department's District Engi
Rotorua, Mr H. J. Myerscough,
Council was informed that it was
possible to give further consid
to the matter until cable exten
were made on Waiariki (the
Road. When cable extensions
made to both this and other are
Taupo, the necessity for further
lic telephone facilities would be
vestigated.

An extravagance is anything
buy that is no earthly use to
wife.

FATHER J. DE BREE.

METHODIST CHURCH.
SUNDAY, JUNE 17.

REV. G. V. THOMAS, B.A.
At Taupo School At 11 a.m.
Preacher: Rev. G. V. Thomas.

BAPTIST CHURCH,
TAUPO VIEW ROAD
(Off Rifle Range Road).
SUNDAY, JUNE 17.

9.45 a.m.: Sunday School.
11 a.m.: Worship Service.
7 p.m.: Rev. Bullen, of Rotorua.
Visitors and Residents will find a
Warm Welcome awaits them at
our Hall.

Lost

BETWEEN Rangitaiki and Taupo,
Hub Cap off Morris Commercial
Truck. Finder kindly return Timber
and Building Supplies.

Entertainments

RUGBY FOOTBALL

SATURDAY, JUNE 16.

SENIORS—

Tongariro v. United, at Taupo, 1.30
p.m.

C.O.B. v. Mokai, at Taupo, 3 p.m.

JUNIORS—

C.O.B. v. H.S.O.B., at Taupo, 12.15
p.m.

Taupo v. Tongariro, at Hiranagi, 2
p.m.

SOCCER.

SATURDAY 16th JUNE.

TAUPO UNITED v.
ROTORUA RANGERS.
SCHOOL GROUND.

Kick off 2.30 p.m.



TAUPO DRAMATIC SOCIETY

Presents
THREE ONE-ACT PLAYS

At the
WAR MEMORIAL HALL
On

TUESDAY AND WEDNESDAY,
JUNE 26 and 27,
At 8 p.m.

TELL IT NOT IN GATH.

By Joe Corrie.

GOOD-BYE, MISS LIZZIE BORDEN.

By Lillian de la Torre.

JOINT OWNERS IN SPAIN.

By Alice Brown.

Admission: 5/-.

Members: Usual Concession.

BOOKINGS AT HARMONY
HOUSE—

Open for Members on Monday 18th
June.

Open for Non-members on Friday
22nd June.

Inrill after thrill with Nature's Cruellest Creatures.

THE SCARLET SPEAR.

Actually filmed in the African Jungle in Technicolor.

Featuring John Bentley and Martha Hyer.

Approved for Universal Exhibition.

TUESDAY, JUNE 19.

A vivid story of a German Circus Romance excelling in
dramatic interplay.

TROMBA.

Stars Rene Deltgen and Hilda Weissner.

Approved for Universal Exhibition.

WEDNESDAY, JUNE 20.

Charlie Chaplin in

MODERN TIMES.

Approved for Universal Exhibition.

THURSDAY, JUNE 21.

Love or Laughter? Which came first in her heart?
Wendell Corey and Margaret Lockwood in

LAUGHING ANNE.

In Colour by Technicolor.

Recommended by Censor for Adults.

FRIDAY, JUNE 22.

Turbulent Drama . . . rocked with the exploding excitements
of an oil strike!

BLOWING WILD.

Stars Gary Cooper and Barbara Stanwyck with Ruth Roman,
Frankie Laine and Anthony Quinn.

Recommended by Censor for Adults.

SATURDAY, JUNE 23, at 2 p.m. and 7.30 p.m.

C-I-N-E-M-A-S-C-O-P-E.

Against the background of Paris . . . romance and
breathtaking suspense.

M.G.M. Presents in Colour

BEDEVILLED.

Stars Anne Baxter and Steve Forrest.

Recommended by Censor for Adults.

ASSOCIATE FEATURE: COMMANDO.

The story of the Green Beret, showing the training of Commando
Troops.

Work Wanted

CASUAL Gardening, etc. Reply
Box 287 Taupo.

Accommodation

SOLWAY FLATS. Holiday and
Permanent, Fully furnished, Fletcher
St., Taupo, Phone 266 S.

TONGA CABINS.

FLATS. CABINS.

BED AND BREAKFAST.

TONGA ST.

Phone 130.

For Hire

BOATS.

CABINS.

OUTBOARDS.

FISHING TACKLE.

Acacia Bay Lodge Cabins.

Phone D. G. EWING, 312,

DON'T BUY IT - - - HIRE IT!

Gravelly Rotary Hoe. Barrows.
Speedecythe Lawn Mowers. Cycles.
Ladders. Chain Saws. Concrete Mix-
er. Saw Benches. Sewing Machines.
Garden Tools. Spray Gun Outfits.
Hand Saws. Vacuum Cleaners
Outboard Motors.

WALLY KILMISTER,
Roberts St., TAUPO, Phone 271.

Situations Vacant

CARPENTERS wanted, 7/- per
hour and overtime; no lost time.
Apply Bradley & Orr, Phone 400 M.

FIRST-CLASS Fitter and Turner,
conversant with sawmilling machin-
ery, Martonair equipment and general
engineering; Housing available
December, 1956; top wages to good
man. Apply Tuck Bros. (Exotics)
Ltd., or write P.O. Box 172, Taupo.

HOUSEKEEPER wanted, end of
July, about a fortnight. Phone 98.

HOUSEMAID wanted; live in.
Apply Spa Hotel, Phone 18.

PAINTER wanted, tradesman.
Ring 223 evenings. Calkin,
Rotokawa St.

TAUPO RABBIT BOARD.

Wanted: Married Man for rabbiting
approximately 26 miles from Taupo;
no experience necessary, but must
be willing to learn and trustworthy;
new free 3-bedroom house available;
no school bus or electricity for ap-
proximately 12 months.

REPLY IN WRITING TO
THE BOARD'S INSPECTOR,
P.O. BOX 74, TAUPO.

no one can
Always
Albert and

A Brigg
Petrol. Eng
Price: £15,
to £30. App
Hatepe, or
Hastings.

ATLAS I
£9. Apply J

BOXER
English Ch
Reasonable
Phone 228.

HAYWIN
condition,
also Sundr
Wheretia S

NEW 2 1/2
stock £57/10

PEDIGRI
condition.
St., Taupo.

TWIN 1
hood, £4. I

CHAMPI
with hot w
ANTIQU
front.

WASHRI
CHESTE

All perfe
for cash. I
6 p.m.

DRESSIN
mirror bac

BED, goo
GALVAN

pattern, 5ft

ULTIMA
good condit

Table, 4ft 3
Apply M

or Mrs. Sti

1939 V8 (

order; gear

needs overk

1950 Be
good order

Hose, £3;
wheels, £5,

Apply D

ANVIL
Paint, Ther

From W.

HOT W
supplies av

BURN. Ha

For Sale
Printed by
Limited at
155 Thame
and Publis
Limited at
Heuheu Str

FRIDA

OBITUARY

Margaret Fletcher

h. of Mrs Margaret F...
r of Mr Fred Fletcher...
rred suddenly on Sun...
her son's home.
ho was aged 78, had...
o district for some tw...
usband, the late Mr...
er, predeceasing her s...

Yorkshire, Mrs Fletc...
ew Zealand with her...
44 years ago. They m...
po district from Na...
s after Mr Fred Fletc...
his fishing lodge at W...
d both Mrs Fletcher...
l were well known am...
ngling visitors to Wa...
r Fred Fletcher was

al took place at Taupo...
ne 12, St Paul's Pre...
ch being crowded for...
2.30 p.m., taken by...
Madill, who also took...
the graveside. The...
ad by the Rev. A. J...
l at the graveside by...
ngohau. Mr Madill...
ngly to Mrs Fletcher...
ad been well loved...
Church but also in...
at large. The hy...
h Me" was sung by...
Fred Fletcher.

earners were Messrs B...
S. Currie, E. P. Tay...
naine, J. W. Woodw...
ung.

**DREW'S CHURCH
L CAMPAIGN**

ly sale of work organ...
Andrew's Church Lad...
ield in Rickit's Tear...
June 14, realised £127...
und for building the...
l. With recent donat...
only is now required...
ost of the Hall.

ltee are working to...
together with a fur...
provide simple furnis...
o. They have expres...
appreciation for ass...
y received, and appeal...
ed in the project to...
to help them in bring...
ign to complete the B...
to a speedy and succ...

ners at the sale we...
s L. Eely, Cake, Miss...
tdress, Mrs M. Morris

OTHER REPORT

ding June 17: Rain...
Sunshine, 11.3 ho...
emperature, 58.9 deg...
um, 35 degrees; H...
by courtesy New Zeal...
al Service).

Administration: Salaries, £3700;
Car Running and Travelling
Expenses (including Advisory Com-
tee Expenses), £650; Postages,
and telephones, £300; Office fur-
niture, fittings and equipment, £300;
Travel expenses, insurances and bank
charges, £470; Miscellaneous, £840;
Total, £6860 (£6873). Reserve for Re-
tirement of Assets, £2000 (£1000).
Contingencies, £1000 (nil). Grand
Total estimated expenditure, £42,200
(£42,224).

**SOCCER CUP PRESENTED
BY MR N. FRANKLIN**

A handsome silver cup, suitably in-
scribed, has been presented to the
Taupo United Soccer Club by Mr
Norman Franklin, a local resident
who has shown keen interest in the
recently formed Club. The donor has
expressed the wish that the cup be
presented to and become the property
of the most improved player during
the season.

At a Club meeting held on Tuesday,
June 12, the president, Mr Howe, ac-
cepted the cup with pleasure and
read a vote of thanks to the donor.
Mr Franklin stated that gestures such as Mr
Franklin's would do much to encour-
age players and at the same time to
assist in building up and strengthen-
ing the Club.

A committee of three was elected
to act as the panel of judges to watch
the progress of players and to report
to the Club at the end of the season
the player whom they considered had
deserved the award.

Use of School Ground

Permission has been granted, stated
the president, by the Taupo District
School Committee, for use by
the Club of the School playing field
on Horomatangi Street for two sea-
sons or until such time as the Club
has access to a suitable alternative
ground. The Club had informed the
committee that they would provide
working bees to level and improve
the ground. Several such working
bees had already been organised. At
the conclusion of the season a fur-
ther concentrated effort would be
made in an attempt to prepare the
ground for next season. A vote of
thanks to the School Committee was
passed unanimously. A further vote
of thanks was accorded Messrs Tuck
and for their gift of timber for goal

Taupo Times
Power Charges 22/6/56

Mr H. L. Boughton, chairman,
Thames Valley Power Board, stated
recently that the State Hydro-electric
Department was likely to finance
part of its capital expenditure out of
the revenue, and if this were done it
could mean an increase in charges
to the power authorities, who were
bulk buyers from the Depart-
ment. Mr Boughton also stated that
the Thames Valley Board would in-
deed have to make ten per cent of
its annual revenue available for
capital expenditure.

INTER-SCHOOL SPORT

The annual Rugby football and bas-
ketball games between the Reporoa
and Taupo Schools took place at
Taupo on Wednesday, June 13, but
were marred by heavy rain, due to
which the girls' basketball match had
to be abandoned after 15 minutes'
play. Reporoa could not break
through Taupo's sound defence, but
though Taupo led by eight goals to
one Reporoa had shown good individ-
ual play and only lacked combina-
tion and experience.

The boys' football match was played
in almost continuous rain. The
heavier Taupo forwards broke
through time and again. Both sets
of backs handled reasonably well un-
der the conditions prevailing. Despite
disparity in weight Reporoa fought
against odds to the final whistle,
Taupo winning 45-0. Mr J. W.
Woodward refereed.

By courtesy of the Borough Coun-
cil and the A.C. Baths caretaker
both teams enjoyed a visit to the hot
baths before returning to the School
for afternoon tea.

INDOOR BOWLS

Bad weather did not prevent a
record attendance at the Indoor Bow-
ling Club's evening on Monday, June
18. Best scores were L. Graf 39, F.
McIsaac 38, Mrs Rewa 32 and Mrs
Righton 28. The June aggregate final
round will be played on Monday
evening next and button holders
should bring them for presentation to
the June winners.

The mixed pairs will be played on
Sunday, June 24, commencing at 8
am. and with 50 games to be played
a strict timetable will be necessary.
Teams not available when required
to play will be penalised by one point
for each five minutes or part thereof
they are late.

NEXT WEEK'S THEATRE

Two Comedies, One Thriller

The Dramatic Society's two night
season, on Tuesday and Wednesday
of next week, should provide a well
balanced entertainment, with three
one-act plays, two comedies and a
thriller on the programme. The
comedies are "Tell It Not In Gath"
and "Joint Owners In Spain", pro-
duced by Keith Christensen and
Jack McBeth respectively. The cast
of the former comprises G. Dudley-
Johnson, Ebba Tier, Dorothy Tilley,
Yvonne West, Noel Williams, and
Keith Christensen.

The cast of the second comedy
comprises Grace Booth, Eunice Bir-
nie, Jean Dixon, Doris McBeth.

The thriller is "Good-bye, Miss
Lizzie Borden," a sinister play pro-
viding a fictitious solution to the
notorious American murder mystery
of 1892, the Borden case. In the
cast are Sally Kent, Linda Coster,
June Armstrong and Elizabeth Les-
ter. Linda Coster is the producer.

Rawhiti, Tongariro, followed through
and was lucky to be awarded a try.
Malcolm again converted.

In the second spell United defended
stubbornly, and made periodic sorties
which looked dangerous but lacked
finish. Tongariro kept the pressure
up and first J. Malcolm, with his
jinky run, beat the defenders to score
near the posts and convert, and after
30 minutes A. Smallman again made
a determined run to score well out.
Malcolm made no mistake with the
kick, and the game ended, Tongariro
21, United 3. Malcolm gained 14 of
the points. Mr K. Rameka refereed.

Mokai v. C.O.B.

C.O.B. attacked from the whistle,
playing an open game, Mokai defend-
ing stubbornly for the first 20 min-
utes. Then from their own twenty-
five the Mokai forwards bustled their
way to C.O.B.'s goal-line and from a
series of crashing attacks S. Andrews
scored. He converted his own try.
C.O.B. were not to be denied three
minutes later when from a forward
and backline movement the ball went
from Koopu to Ham, who touched
down. Koopu converted and the score
was even. From this time the whole
initiative switched to Mokai and by
half-time Andrews had again scored.
Winiata added to the points with yet
another try which Andrews con-
verted.

Upon resumption Mokai turned on
the fireworks and play was very live-
ly. After nine minutes McFadgen gath-
ered in a loose ball from a charged
down kick, and again Andrews goal-
ed. C.O.B. fought back, and though
never completely on top, had the bet-
ter of the last 30 minutes. It was
not long before F. Biddle goaled
from a penalty and the margin be-
tween scores narrowed slightly.
C.O.B. threw the ball about but the
cover defence of the Mokai forwards
upset their movements and though
they were dangerous several times
they could not score until Mokai in-
fringed in a handy position right on
time and again F. Biddle goaled. The
final score was Mokai 18, C.O.B. 11.
S. Andrews scored 12 of Mokai's
points.

R. Seymour proved very elusive at
centre for Mokai, and his reverse
pivot when on defence bewildered the
opposition. G. Kapua was always on
the ball and led the Mokai forwards
extremely well. Mr Doug Dalton,
Hawkes Bay Rugby Union's selector,
was on the sideline for both games.

**OPTI
FLETCHER AND
HANSBY'S
Next Visit : W**

Mrs Foote and Miss Branson have been selected for the Thames Valley-Bay of Plenty team to meet Waikato at Cambridge on June 22, with Mrs Thomas as an emergency.

Men's Golf

The first round of the Middlemore Mugs competition was played on Saturday, June 16, with the following results:

D. Logan and G. Sutherland beat G. Foote and W. T. Irvine; A. Graham and E. J. Ryan beat H. Fearn and L. Holdsworth; G. Comer and N. Williams beat T. Price and G. Reed; G. Fraser and L. Smith beat F. Bostock and N. Kerr; G. Barlow and K. Young beat J. Watson and J. Thomas; G. McDonnell and G. Thomas beat A. Durrand and S. Columb.

The individual Stableford was won of N. Kerr with a score of 37. T. Price also returned a good card.

On Sunday, June 17, several Club competitions were continued. The individual trophy was again won by N. Kerr. J. Watson and L. Holdsworth also returned good cards.

Handicap reductions: N. Kerr, 10 to 8; J. Watson, 21 to 20; T. Price, 15 to 14.

SOCCER AT TAUPO

United Draw With Crusaders

In what was probably the first Soccer match to be played in Taupo, the Taupo United team played a no-score draw on Saturday, June 16, with Crusaders, of Rotorua, undefeated leaders in the competition. A feature of the game was the splendid play of the Taupo goalkeeper, L. Alkema, who was on the day unbeatable.

The game opened at full pressure and the pace was maintained throughout. Full honours went to the defence of both teams. Excitement reached a peak with Alkema's saving of a goal from a penalty kick by M. Hetmanczyk a few minutes before time. Good service for Taupo was also done by R. Girling, at right back, J. Schmidt, at centre half, S. Kempton, at left half, and G. Millar, at inside left. Mr C. Mulligan refereed.

Four Taupo players are to take part in the representative trials at Rotorua this week-end, Messrs L. Alkema, G. Drummond, T. Doyle and A. Miller. To-morrow's home match has been postponed.

New Main Street Building

Good progress is being made by the contractor, Mr A. Rose, with erection of a two-storey concrete block building in Tongariro Street, between the R.M. Garage and Story's Buildings, for Messrs Wong and Sefton. The ground floor will be used for the owners' electrical business and the upper storey will provide office accommodation.

Taupo Times 22/6/56

SPECTION

Standard, Climbing.

Including Rhodoc, Liquidamber, Birch, Kalmia, (s), Fordythia, zle, Grevilleas, er, Ericas (30)).

IES, CHERRIES,

newest Shrub s.

ES— all as the new and Pears.

a, Lonicera. variety.

HILEY AVENUE. 364.

NG EXTERIOR FINING

Shop or Office operated by

ID & SON

oderate Charges.

UVE, TAUPO. 64 K.

UGGESTIONS

RESTAURANT

and Tea or

ip and Toast.

t these premises ay on Saturday, g on Sunday, l.

KEFRONT 126



SERVICE—

ICE CO.,

FOA ST., 380.

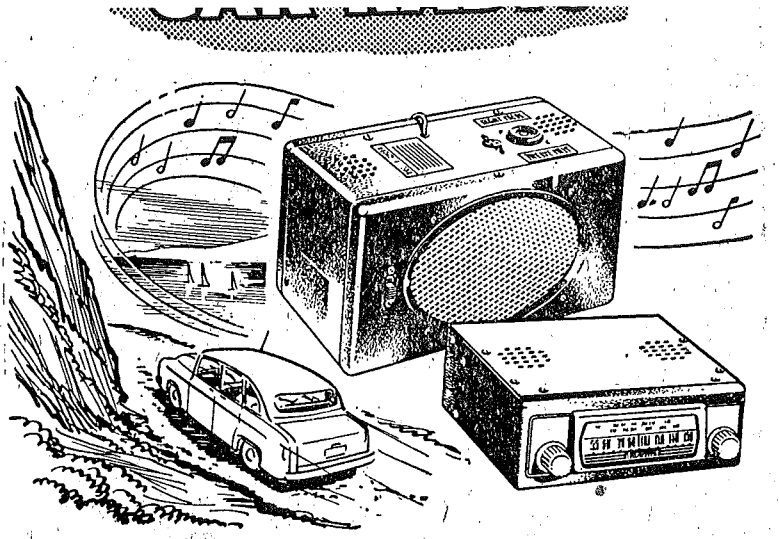

6-volt and 12-volt, 8-valve, £36/5/.

And

THE NEW PUSH-BUTTON RECEIVER

At

£37/19/6.

SEE THESE LATEST CAR RADIOS

At

LOCKYER'S

(TAUPO) LTD.

Opposite Post Office

Phone 116M

see into the future

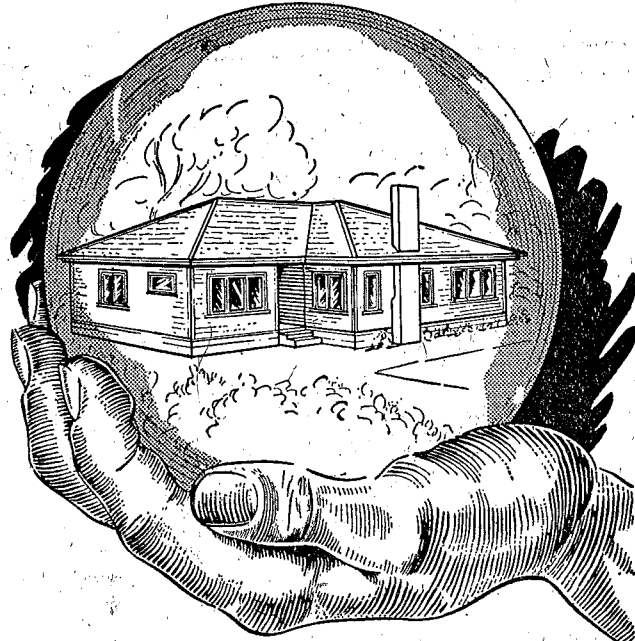

WE HAVE NOW ERECTED A DEMONSTRATION HOUSE IN SELKIRK STREET ADJACENT TO OUR MAIN OFFICE. When visiting Hamilton you are cordially invited to this house and see the standard of workmanship that goes into all our "Ready-to-erect" Houses.

Residents in Taupo and surrounding districts may now obtain the many advantages of "Ready-to-erect" by contacting our TAUPO AGENTS, MESSRS. PRIME & MOREL, Heuheu Street, for details, or by writing direct to the Manufacturers—

ELLIS & BURNAND LTD.

P.O BOX 3

BRYCE ST. Phone 81-149.

HAMILTON

problems inevitable; job, be it an otherwise, there has ss and an absence ident of any sort, volumes, in such a care and foresight in the work.

another significant place nearby. On between the Rotorua ne Waikato River, warm creek from, an area of scat-assy patches, where but recently went as been cleared and piles of aggregate rk has been stock-ected, and near the he flat, close to the vated for a geother-ration station.

een announced that will have an output ts. The steam sup-on is already avail-resent rate of drill-second station, pro-is being made in the ould be available s been stated recent-t station should be iter of 1958.

the right of the Ro-opposite the point ary road to the new ay joints the Roto-ave been erected for ry staff of the Geo-and other Depart-ling on the west side just north of the y access road, is a men of the super-

of the first access to the works area hwy and the river, les of graded shingle concrete, growing rcing rods, together tel pipes. Of metric ese are approximate-1 diameter, and are hich will pipe steam a Valley bores to the ower station.

tion site itself is close the southern end of opposite the Atiamuri road (see front page issue). South of the uilding for the super-the various Depart- engineering consult-

rn end of the works nt camp to house 100 will be employed by who will be building on. There, also, is a g room and ablation terer's cottage.

, Ltd., of Wellington, he steel framework of contract covers the power station on the

a mile to bring steam from the bores.

Four firms are undertaking the work as a joint venture. They are: Holland and Hannen and Cubitts, Ltd., of London, a firm specialising in heavy civil engineering and building construction; Conrad Zschokke, of Switzerland, a leading European firm of civil engineering contractors; Munro and Miller, Ltd., of Glasgow, which has extensive experience of both land and marine steam piping installations, and the New Zealand firm, the Williamson Construction Co., Ltd., of Christchurch.

Under the administration of the Ministry of Works, detailed supervision will be exercised by consulting engineers' representatives and, as in the case of hydro stations constructed by the Works Department for the State Hydro-Electric Department, the installation of the generating plant at Wairakei will be carried out by the latter department.

SOCCER AT TAUPO

Win For Kawerau Visitors

Taupo United Soccer team were outplayed by a strong Kawerau team in their second game on the Taupo District High School Ground on Saturday, July 7, the visitors winning by 7 goals to 1. Kawerau attacked strongly and found no difficulty in placing the ball to their advantage. Their first time shooting paid dividends and they were a goal up after three minutes, followed by further goals after six and nine minutes play.

Taupo defence was hard pressed and the halftime score was Kawerau 6, Taupo 0, all goals being well placed and giving F. Howe, Taupo's hard worked custodian, little chance of saving. On resumption Taupo played with renewed vigour and were rewarded with a goal when a strong shot from the foot of outside-right T. Doyle, following a well-placed centre from W. Harding jun., beat the Kawerau keeper.

Play was now very even with the Kawerau forwards still dangerous and in the seventieth minute of play the Taupo keeper was again beaten when a strong shot scraped in under the bar. The game's closing stages were enlivened by Taupo's left-back, H. W. Matthews, who left his customary defensive position to beat a number of Kawerau players and make lone sorties into Kawerau defence. The game ended with the score 7-1 against Taupo.

Full marks went to H. W. Matthews for his brilliant efforts and to W. Harding jun., for improved play, and to the Kawerau team for their impressive win and high standard of sportmanship. Mr Arthur Kennedy was the referee. To-morrow, Saturday, July 14, Taupo United will again be on the home ground to play Rotorua Caledonians at 2.30 p.m.

Re-Zoning Suggestion

As authorised agent for Mr Tom Couper, Mr T. M. Kent, in a written application, asked for a review of the Town Planning Scheme as regards Sections 1 to 6, inclusive, Block 28, Town of Taupo, on the grounds that the locality was more suitable for a commercial area, than for a light industrial area as at present zoned. The sections mentioned, front Atiamuri Street, which is the road forming the main highway from the north end of Tongariro Street to the Control Gates Dam.

Mr Kent stated that there could hardly be any objection to the proposal, as main street frontages in Taupo were not now available, except for one 34 feet frontage section for sale on his books at a price of £125 per foot. The frontage concerned in the application would, he felt, present a poor approach to the town if retained as a light industrial area. Firewood yards, etc., would not be attractive.

Alternatively, with the improvement of the Taupo-Atiamuri Highway, he thought a vastly increased overnight accommodation demand would develop in Taupo, as Rotorua would be by-passed by a large number of the travelling public. The present stage in Taupo's development was one when possible anomalies in town planning might be investigated, and possibly the Town Planning consultant himself might welcome an opportunity to review the progress of the town since his original scheme was approved.

In discussion by the Council it was pointed out that the roadway concerned was not aligned as shown on the town map, and that a report and plan in connection with this was being prepared for the Council by Messrs Cheal and Nelson, surveyors. It was decided to defer consideration of the application until the plan mentioned was available.

Borough-County Engineer

A letter to the Council from Cr J. M. Stanley, suggesting that the Council should approve the appointment of a civil engineer whose services would be jointly shared with the Taupo County Council, was brought forward from a previous meeting. It was agreed to defer consideration in view of the fact that there was only a bare quorum present, and of the fact that the report on the Council's administration system, being prepared by Mr T. Ashby, former Town Clerk, Auckland City, was expected to be available at an early date.

Use of Pinus Radiata

The matter of the use of radiata pine in building, brought before an earlier meeting by Mr C. O. Webb, Building Inspector, who had mentioned the many anomalies created by the present restrictions on its use, was again brought up. Mr Webb, who was present, stated that the State Advances Corporation were now

inch. Sunshine, 29.5 hours. Maximum temperature, 55.2 degrees, 7th; minimum, 31.1 degrees, 7th. Frosts, .08 degrees, 4th; 9.1 degrees, 6th; 0.2 degrees, 7th; 3.9 degrees, 8th. (Published by courtesy New Zealand Meteorological Service).

INDOOR BOWLS

Thirty-two players took part on Monday evening, July 9, in the second round of the Taupo Indoor Bowling Club's July aggregate. Highest points in both men's and women's sections were: J. Walpole, 33; G. Rameka and F. Meggitt, 29; Miss G. McIsaac and Mrs Banks, 29.

Other scores were: Men, F. McIsaac 28, G. Kemble 27, C. Banks 25; J. Brown 23, A. M. Tierney 23, P. Pearson 23. Women, Mrs Christensen 24, Mrs McIsaac 23, Mrs Tierney 22, Mrs Tier 21.

WEARWELLS SALE !

NOW ON !

Be Early. Bargains For All.

Winter Coats From £6/5/-.

W.-W.X.-O.S. Dresses. From £2/19/6.

Skirts From only 39/6.

Brushed Wool Cardigans 40/-.

Flannel Slacks, all sizes 37/6.

10% Discount off all Wool Coats, Costumes, Hats, Skirts, etc.

Save 2/- in the £.

WEARWELLS Taupo Branch.

CAR SALES (PUTARURU) LTD.
Phone 208 S. PUTARURU.

GOLIATH, LAND ROVER, SKODA.

1955 Land Rover; 7000 miles; 107in; nearly £300 below present list price.

1956 Skoda (new car), 4-door, 6-seater. List price approx. £960

1952 Alvis; 2 owners; push-button radio; heater; washers; all tyres 100%; 30,000 miles £1185

1951 Citroen; very good order £595

1951 Morris Oxford; ex taxi, but good order £465

1950 Bradford De Luxe A/W, with rear seats; still on original tyres at 23,000 miles £285

1936 Reo Sedan; very good order £180

1953 (Dec.) Ford Thames 3-5-ton, flat deck; fully-reconditioned motor; one owner £465

1955 Morris Oxford Pick-up; 12,000 miles £695

1953 Karrier 10cwt; 1 owner; heater £525

1936 Fargo Truck, with hoist £165

1934 Chevrolet Van; going order £45

30-40 other Cars and Trucks, both post-war and pre-war.

We will gladly demonstrate in your district without obligation. Just telephone us.

CAR SALES (PUTARURU) LTD.

PO'S NEW TELEPHONE EXCHANGE TO BE "CUT IN" ON JULY 28

New Taupo Telephone Exchange will be "cut in" to service to week, Saturday, July 28, at The change-over from the exchange will, it is expected, smoothly, but the engineers in and the exchange staff, will be greatly assisted if subscribers will co-operate by making a point of restricting telephone calls, from 8 a.m. to 2.30 p.m., on the day named, to those that are absolutely essential only. After 2 p.m. the telephones must not be used.

The telephone subscriber the obvious difference in the new will be that his telephone will not handle. In most cases it will be similar in appearance to an automatic telephone, but with no dial. The telephones supplied, however, will be the automatic dial, but this should be disregarded. The dial should not be operated under any circumstances. All dials will be read with "dummy" dials later. After the old telephones are removed. After two p.m. on Saturday, July 28, subscribers must use the new telephones, which have been placed beside the old ones, and before the "cut in" of the new exchange all subscribers will receive cyclostyled instructions with full details as to the operation of the new telephones.

In conversation with the Taupo Postmaster, Mr L. F. W. Sworth, emphasised that the Exchange would service calls coming in the time of the "cut in", but if subscribers made calls about time only if they were really necessary, as mentioned above, it would be much appreciated and would be a great help.

To make a call with the new machines, on individual telephone lines, is only necessary to lift the hand-set, and ask for the number required when the operator answers, or to ask for "Toll", as at present, if a toll call is to be made. To answer a call, merely lift the hand-set and speak. It most important that the hand-set be replaced after each call.

Subscribers on party-lines must lift the hand-set to ascertain if the line is engaged, replacing the hand-set immediately if it is so. When the line is free, the exchange is called by lifting the hand-set as explained above for individual lines.

When the party-line subscriber wishes to call someone on his own party-line, however, he must lift the hand-set; when the operator answers must give the number and code number of the subscriber on his own line whom he wished to call, and then replace his hand-set immediately. When the ringing has stopped he should lift the hand-set and wait for the wanted subscriber to answer. When a wanted subscriber does answer, and the caller wishes



TIDYING UP THE LAKE FRONT

A further step has been taken by the Borough Council recently in pursuance of the policy of gradually improving the condition of the Lake front area. This was the removal of several large pine trees from the triangular reserve bounded by the Lake front highway, Ruapehu and Roberts Streets. The work has been carried out by a local contractor, and one of the large stumps is seen above being manoeuvred by bulldozer into a truck. During recent heavy wind off the Lake it was discovered that one of the trees was swaying dangerously, so that its root system was lifting the ground about it, to the obvious risk of cars parked nearby. The Council plans to level the area and plant it with trees suitable in size for the situation.

END OF NEED FOR BREAD FROM NAPIER

Thanks To Those Who Helped

With the opening of a second bakery in Taupo recently, as reported in last week's Times, the emergency supply of bread for Taupo from Napier, organised last September, has become unnecessary. In conversation with the Taupo Times, Mr W. L. Haines, chairman of a committee set up by the Taupo bread retailers to deal with the emergency, which arose owing to the closing of one of Taupo's two bakeries, said that the problem could have been a very sticky one.

Mr W. Braddock, proprietor of the remaining bakery, had co-operated fully with the committee by baking to the utmost capacity of his plant, but considerable additional supplies were essential, especially with the summer season impending.

Arrangements had been made with Mr T. McLeod, of the Parade Bakery, Napier, for a supply, and for about ten months this had filled the gap in Taupo's bread requirements. Mr McLeod had been most helpful and reliable, and had done the people of the district a valuable service, for which, on behalf of those associated most closely with the problem, he ex-

KINDERGARTEN DANCES AND HALL CHARGES

A letter received at the Borough Council meeting on Wednesday, July 4, from Mr G. Marlow, Treasurer, Taupo Free Kindergarten Association, gave details of expenditure and receipts in connection with a series of five Saturday night dances arranged by the Association in order to raise funds. After reference to the purpose of the series of dances, the letter continued:—

"The Association consider it may be of interest to you to know the result of this series. The charges were 5s single and 7s 6d double which is considered a trifle high for this type of dance. Total takings: £118 5s. Expenditure: Hall £50, Orchestra £50, Supper £6 19s 6d (much of which was donated), Advertising £4 13s. Total: £111 12s 6d. Nett: £7 12s 6d.

In conjunction with the dance, to popularise it, we ran a progressive Monte Carlo dance, with total prize money of £25, the results of which were: Total takings £66. Expendi-

FIRST WIN FOR TAUPO SOCCER TEAM

Rotorua Team Beaten 3-1

Following their 7-1 defeat by Kawerau the previous week, positional changes were made in the Taupo United soccer team for their match against the Rotorua team, Caledonian United, played at Taupo, Saturday, July 14. The Taupo team emerged winners by three goals to one, notching their first win.

Opening stages of the game were fairly even, with exchanges mostly in mid-field, neither goalkeeper seriously troubled, and Taupo perhaps having a slight edge on Caledonian. After 20 minutes' play, following a determined Caledonian attack, an infringement in the Taupo penalty area resulted in a penalty, the spot-kick being well saved by Taupo keeper F. Howe, his effort drawing a round of applause from spectators.

Taupo were now pressing their attack but good midfield play was being spoilt by poor finishing in front of the goal, and half-time came with no score by either side.

Caledonians attacked strongly on resumption, but also lacked finishing ability, and Taupo again appeared to be having the best of the exchanges. After 13 minutes' play, however, a determined attack by the visiting forwards and faulty positional play by the defenders saw the Caledonian centre-forward make no mistake with a shot that gave Taupo's keeper no chance and put Caledonian one up.

Following this setback Taupo attacked strongly and Taupo centre-forward, B. Braddock, found the back of the net, but only to be ruled offside. The Caledonian goalkeeper was now being kept fully occupied and 28 minutes from resumption was beaten by a strong shot from B. Braddock. From then it was nearly all Taupo, and three minutes later their left-winger, H. W. Matthews, moving up from his defensive position, made no mistake with a first-time shot into the corner of the net to make the score 2-1 in Taupo's favour.

The visitors were now being outplayed and a few minutes before time Taupo made sure of their first victory, when winger Matthews again beat the defenders and scored his second goal, to make the final figures Taupo United 3, Caledonian United 1. Taupo's win was well deserved, but both teams showed weak finishing and faulty positional play, and will need to make improvements in this respect to compete with club teams such as Kawerau.

The Taupo team was: Goal, F. Howe; R. back, R. Gurling; L. back, T. Drummond; R. half, R. Alkema; C. half, C. Smit; L. half, S. Kempton; Outside R., J. Stebbing; Inside R., T. Doyle; Centre forward, B. Braddock; Inside L., A. Moller; Outside L., H. W. Matthews.

OPTICIAN

G. T. A. McCLELLAND
F.S.M.C. (London)
WILL VISIT TAUPO
ON
WEDNESDAY, AUGUST 22.

For Appointments Ring
MR. G. FRASER
CHEMIST—TAUPO
Phone 140 M.

T. WYLIE,
FIBROUS PLASTERER,
TAMATEA AVENUE.
For Messages: Phone 213.
Job Too Big. No Job Too Small.

CLARKE'S

T DRINKS & CORDIALS
NOW OBTAINABLE FROM
OUR DEPOT—
PIHANGA ST., TAUPO
Phone 540.

PULLOVERS

TO SUIT ALL TASTES.
German Knit Crewe Neck
PULLOVERS. Long sleeves. Assorted
colours. Extra heavy weight.
Men's Size: 77/6. O.S.: 84/-.
SLEEVELESS PULLOVERS. Good
range of shades just arrived.
Priced 29/11 to 35/-.
V-NECK SWEATERS. All
colours. Plain and Striped Designs.
Special Price: 79/6.
SOMETHING NEW FOR TAUPO—
MEN'S PULLOVERS MADE TO
ORDER. Any colour you require.
Delivery in 14 days.

M. R. RICHARDS LTD.
"Famous for Lower Prices."
Opposite Post Office,
TAUPO.
Phone 515. Box 300.

J. S. BURROWS LTD.
BULLDOZING CONTRACTORS
Specialise in All Types of—
EARTH MOVING.
ROAD MAKING.
ROAD GRADING

**WAIRAKEI POWER HOUSE
MEN INTERESTED
IN SPORTS IN TAUPO**

The recent arrival at Wairakei of men from Roxburgh, who have been engaged by the contractors for the erection of the Geothermal Power Station, appears likely to be of considerable interest to sports circles in Taupo.

When Mr F. Howes, president of the Taupo United Soccer Club, and Mr R. Gurling, a club member, recently visited the works camp, they found great interest not only in soccer, but in all other branches of sport. A Sports Committee had just been set up at the camp, and the visitors found themselves called on for information, not only as to soccer, but as to all other sports in Taupo.

They found that a soccer team from the works camp will be taking part in next season's competitions, that a cricket team is already arranged and expects to take part in the Taupo Cricket Association's fixtures, and that a Rugby team is also likely to be playing in Taupo Rugby Sub-Union competitions next winter.

Enquiries were also received as to whether there was a gun club in Taupo, and as to any Taupo darts organisation, as well as with regard to table-tennis. It appears that local sports organisations would be likely to find considerable further support for their various activities if they got in touch with the Sports Committee at the Power House job works camp.

SOCCER NOTES

Taupo United met Rotorua Rangers at Taupo on Saturday, August 4, in the final game of the soccer competition. Rotorua Rangers, with one game to play, are hot favourites for the championship. On Saturday's play they proved their position as leaders, adapting themselves to the adverse windy conditions, whereas Taupo, with the wind in their favour in the first half, failed to use it to their advantage and by half-time had not a sufficient lead before going off to defensive play with the score at 3-3.

Taupo in the second half played good defensive football and made Rangers fight all the way for their victory, with the final score Ranger 6, Taupo 3.

Next week Taupo play Whakatan away in the first game of the Tai Mitchell Shield competition, and with the help of new players from Wairakei will be going all out to bring this trophy to Taupo.

Sunday's friendly game against the newly formed International Contractors' team from Wairakei was a success for the Taupo team who won by two goals to nil.

INDOOR BOWLS

LAKE FRONT GARAGE LTD.

Phone 597. Phone 597.
SERVICE STATION AND GARAGE

B.P. PETROL AND OIL.
ENERGOL GREASING SERVICE.
24-hour Breakdown Service,
BOATS FOR HIRE.

Taupo Agent for—
SEAGULL OUTBOARD MOTORS.

HARCO GAS **LIDGARDS FIBRE GLASS**
B.P. COMPROX **COVERED BOATS**
HOUSEHOLD DETERGENT

**FOR ANYTHING TO DO WITH
WATCHES**

Our Large Selective Range Includes—

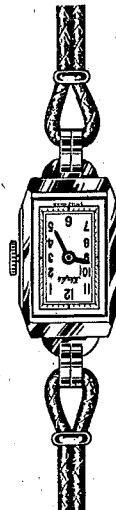

- OMEGA—
Gentlemen's From £18/11
- Ladies' From £11/11
- HAFIS—
Gentlemen's From £11/11
- Ladies' From £11/11
- ROAMER—
Gentlemen's From £13/11
- Ladies' From £12/11

ALSO—

- DOXA. ETERNA. TISSOT. TITAN. TIPTOP.
- SAMAR. NOVERA. BUREN.
- WHITE STAR. PIERPONT.
- Lovely MARCASITE-MODELS.



By far the Finest Selection in Taupo.

McCLURGS LTD.

TAUPO'S JEWELLERS.

Phone 356 TONGARIRO ST.



BOILERS

FIRTH

in various Taupo which the public contributions, every as one vote. of the competition nesday, October 31. e counted, and the nts will receive a ea each. Voting lists will then con- November 30, and be counted on the the winner of the panying prize an-

etition is being ar- a. Others held for oses in a number have roused much ed in the raising of

BUS SERVICE ATIONS

ded during past upo suburbs bus ser- st disappointing and J. W. Storey, who ver from Mr S. A. ces a complete re- services commencing gust 20.

s many as possible ssary to reduce the ices and alter times periods of maximum on in fares will be st three sections. uses that re-organisa- to put the service on It will depend upon d whether further be necessary, by way or decrease in ser- states that he hopes fare concessions if amended time-table

BASKETBALL TCHES

es of the Taupo Bas- on's 1956 competition i the War Memorial Saturday, August 11. s were seen, though a heavy wind made

irls, though playing both their games, H. Maniapoto goaling Williams in defence onents' scores down. s are the winners of with Taupo runners- f all points will be olication next week. y were:

10, Mokai 7; Tonga- ; Tongariro 7; Taupo anu Primary School ry School nil; C.O.G. 6; C.O.G. 17, Spa 11; H.S. B 1; Taupo 12,

Knock-out Competition at Taupo on Saturday, August 11, Tongariro defeated College Old Boys 11-6, extra time having to be played to secure a decision following a six all draw at the expiration of the second half. The game was fast and open and one of the best seen here this season, with both sides throwing the ball about freely.

Tongariro's backs functioned well and were pretty constantly on attack, good defence by Old Boys alone preventing a higher score. Though outweighed, the Tongariro forwards more than held their own in the tight and in set scrums, ably led by their captain, J. Rawhiti Downs and Mihini were the pick of the Old Boys pack, both toiling hard.

Tongariro scored first, Malcolm going over when the ball, travelling from set scrum to R. Grace on the wing, was in-passed to him by Grace. The kick left the score 3-nil. G. Blake, second five-eighths for Old Boys, then scored two tries in succession, both unconverted, for a half-time score of 6-3 in favour of Old Boys.

Blake's first try came from a back movement, when he side-stepped his way through the opposition, and his second from a blindside move started by Eru from a set scrum, Blake going over in the corner. Koopu, Old Boy's New Zealand Maori rep, playing on the wing, failed with both kicks.

Shortly before time Elwin Grace, on the wing for Tongariro, got the ball from a movement from a set scrum, cut in and hurled himself over the line to make the score six all at time. Extra time was then played, and three or four minutes play saw Sadler, Tongariro's No 8, score when a dribbling rush took the ball over the line, Malcolm goaling from near the twenty five to give Tongariro an 11-6 win and the McKay Cup for 1956. Mr Kori Rameka was the referee.

TAUPO BEATS WHAKATANE AT SOCCER

The Taupo United soccer team, recently reinforced, now has the makings of a strong combination. It met Whakatane on No. 2 Ground, Kuirau Reserve, Rotorua, on Saturday, August 11, in the first round of the Tai Mitchell Shield competition, and returned victorious by three goals to two.

In a hard game on a muddy pitch the Taupo defence adapted themselves to conditions. Their forwards had more than their share of the game but did not work together. The three goals scored were all good ones but many chances were lost. J. Braddock and P. Henry, halfbacks, put in sterling work both on defence and attack. Henry has recently arrived from Roxburgh and should be a notably useful acquisition.

Taupo's goals were scored by I. Jones, G. Redemaker and E. McMahon. Taupo are to play Rotorua Crusaders at Taupo this week-end.

Taupo Times 17/8/56

P. Hura 663, H. te Heuheu 662, T. A. Grace 635, J. T. Asher, junr., 557, T. te Tomo 484, R. K. Kepa 427, H. H. Rihia 420, K. te Kuru 418, H. Mariu 369, J. Wereta 309.

ever, on hearing of the financial position, generously made a donation of £10 toward the bus costs, thus enabling the Club to "break even" on the concert.

Quality Shoes. Reasonable Prices. Personal Attention.

SHOES

AT THEIR BEST.

Come and see for yourself.

LADIES	Fashion or Casual Shoes.
MEN	Dress or Work Shoes and Work Boots.
CHILDREN	English Shoes and New Zealand's Best Makes.

ALL THE FAMILY CARED FOR.

TAUPO SHOE STORE

Opposite the Post Office.
Telephone 129.

Quality Shoes. Reasonable Prices. Personal Attention.

large or small you build for less

in HARDIE'S FIBROLITE

ASBESTOS-CEMENT SHEETS



Why wait to build that week-end cottage, garage, boat-shed or fowl-house when you can build it NOW at a cost within your reach in Hardie's Genuine "FIBROLITE." "FIBROLITE" definitely cuts building costs because it reduces labour, painting and upkeep costs. "FIBROLITE" Asbestos Cement Sheets for interior and exterior walls and ceilings are easily and quickly erected. "FIBROLITE" is fire retardant, proof against vermin, weather-proof.

FOR PERMANENCE . . .
FOR LOW COST . . .
BUILD NOW IN "FIBROLITE"

W. L. FULLJAMES

RUAPEHU ST., TAUPO.
Phones: 104 S Business. 104 M Residence.

PIHANGA ST., TAUPO

Phone 540.

J. S. BURROWS LTD.

BULLDOZING CONTRACTORS

Specialise in All Types of—

- EARTH MOVING.
- ROAD MAKING.
- ROAD GRADING.
- SECTION CLEARING.
- GIANT DISCING.

TAUPO DEPOT—

L. H. AMUNDSEN, SPA RD., Phone 270.

QUALITY MEATS

From

HAWKE'S BAY PASTURES.

TAUPO MEAT SUPPLY

E. T. SMITH.

OPPOSITE THE POST OFFICE.

Phone 427.

TROUSER SPECIALS

GLAS GREY WORSTED SPORTS TROUSERS.

Clip on waist or loops.

Special Value—82/6.

MAKI DRILL TROUSERS.

Wide straps and extended band.

26/11 and 31/6 per pair.

PROKEE SPORTS TROUSERS.

Super-quality Worsted. Clip on loops.

Extended band. Worth 5/19/6. Special Price—95/-.

See the Display of

CHUKKA SPORTS SHIRTS

for Summer Wear.

R. RICHARDS LTD.

MENSWEAR STORE.

Famous for Lower Prices."

Phone 515.

TAUPO.

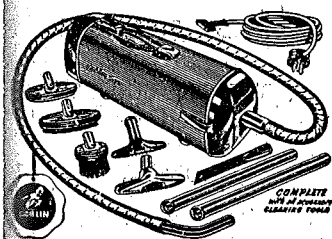

OBTAINABLE FROM

LOCKYERS (TAUPO) LTD.

Tongariro v. Taupo H.S. B, court 2, K. Bogue; Mokai v. Taupo H.S. A, court 1, K. Bogue; C.O.G. v. Taupo, court 2, N. Bates; Tokaanu H.S. v. Tongariro, court 1, C. Rewa; Spa v. Taupo H.S. B, court 2, S. George; Taupo H.S. A v. Taupo, court 1, C. Fowler; C.O.G. v. Mokai, court 2, K. Bogue; Spa v. Tongariro, court 1, C. Pitiroi; Tokaanu H.S. v. Taupo H.S. B, court 2, C. Rewa; Mokai v. Taupo, court 1, M. Tamaire; Taupo H.S. A v. C.O.G., court 2, N. Bates.

All players are to report on the courts at 12.45 p.m.

SOCCKER NOTES

The Taupo United soccer club's hopes of winning the Tai Mitchell Shield were dashed with their defeat on Saturday, September 1, by the league champions, Rotorua Rangers, 4—1.

The game started in fine style with Taupo putting on the pressure, Rangers' defence being well tried. Rangers began to tighten up the game and gave the Taupo defence some hectic moments, one of their attacks resulting in their first goal.

Shortly after Taupo goalie, F. Howes, gave away a penalty for heavy tackling, but made amends with a good save from the spot kick. After several goal-mouth melees Rangers scored to make the half-time figures 2—0 against Taupo.

The second half began with Taupo on attack and after several misses J. Braddock opened the way for G. Parker to make the score 2—1.

Following a mis-kick by a Taupo defender, however, Rangers went further ahead, netting again before the final whistle to make the final figures 4—1 in their favour.

Full marks must go to R. Girling, at fullback for Taupo, for his handling of the Rangers' lively left-wing pair, and also to G. Imlah on his first game for the Club. The half-backs had an off-day, but of the forwards P. Henry and A. Robinson put on a good display.

This match finished this season's competition soccer for Taupo United, but the team are looking forward to the friendly game against the Taupo Rugby Football Club fixed for September 16. The previous Sunday's friendly match against the International Contractors (Wairakei) team resulted in a 4-all draw.

Taupo Times 7/9/56

WATER PUMPS

Deep Well and Automatic Pressure Pumps

SALES and SERVICE

GEO. BEALE

Taupo Machinery Exchange Phone 108

SERVICE

ALLAN WILSON MOTORS LTD.

MOTOR ENGINEERS

P.O. Box 164. TUWHARETOA ST. Phone 585.

JOINERY

EXTERIOR AND INTERIOR

FLUSH DOORS AND ALL TYPES OF GLASS DOORS & SHOP FITTINGS.

ALL GRADES RIMU DOORS, DOOR JAMBS. SPECIALISTS IN ALL FORMICA FITTINGS. BUILT-IN HOME FURNISHINGS.

TWO WEEKS' DELIVERY.

FREE ESTIMATES.

TRY US.

ROTORUA INTERIOR JOINERS LTD.

WAIROA ROAD, ROTORUA.

Phones: Shop, 228 K. Residence, 876.

CONCRETE EVIDENCE

of perfection is shown in this reinforced pumice chimney ready for erection. Available at once from your local dealer. This is one of many different models designed to suit every possible site and purpose. Examine the evidence yourself.

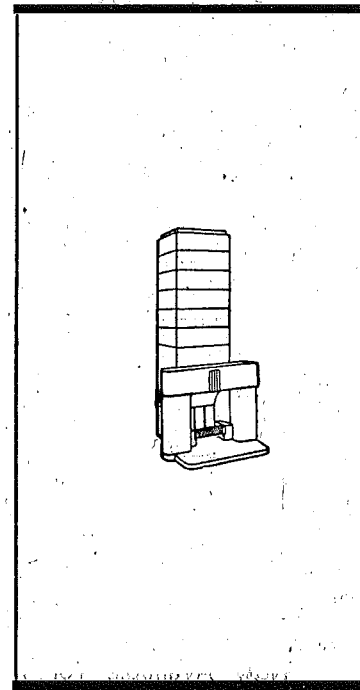

FIRTH CONCRETE LTD

- Frankton
- Rotorua
- Stratford
- Hastings
- Putaruru

TAUPO AGENT: W. L. FULLJAMES.

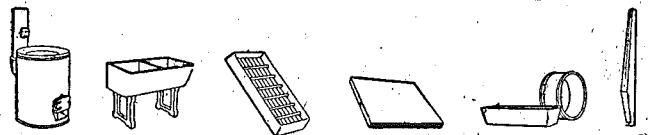

G.2.

OPTICIAN

G. T. A. McCLELLAND

F.S.M.C. (London)

VISITS TAUPO REGULARLY.

For Appointments Ring

MR. G. FRASER, CHEMIST, TAUPO,

Phone 140 M.

LAKE FRONT GARAGE LTD.

Phone 597.

Phone 597.

SERVICE STATION AND GARAGE

B.P. PETROL AND OIL.

ENERGOL GREASING SERVICE.

24-hour Breakdown Service.

BOATS FOR HIRE.

Taupo Agent for—

SEAGULL OUTBOARD MOTORS.

ARCO GAS
P. COMPROX
HOUSEHOLD DETERGENT

LIDGARDS FIBRE GLASS
COVERED BOATS

ALL
BEST SELLERS
THIS SEASON.

McGREGOR—OF AMERICA—
SPORTS WEAR

SWIM TRUNKS

in all the latest shades.

BEACH SHORTS.

LEISURE SHIRTS from 33/6 to 39/6.

JACKETS from 82/6 to 99/-.

JANTZEN BEACH WEAR

BOXER SHORTS.
33/6 to 49/6.

ELASTIC SWIM TRUNKS.
39/6 to 54/6.

LICHFIELD Osmaline Cream Shirts
for Bowlers.
54/6.

MITCHBILT "Townsmen" Spun Rayon Shirts.
Two Pockets.
32/6 to 36/-.

BOYS' TEE SHIRTS—5/9 to 8/3.

MEN'S ISLAND SHIRTS—18/9 and 17/6.

BOYS' ISLAND SHIRTS—10/3 to 13/9.

SEE THESE STYLES & TRENDS IN MEN'S & BOYS' WEAR

AT

DICK FRASER

THE MEN'S SHOP - - - TAUPO
Telephone 387 D.

**TAUPO SOCCER CLUB'S
SUCCESSFUL SEASON**

In a report on the completion of the Taupo United Association Football Club's first season the secretary, Mr J. L. Burge, states that the formation of the Club, which had at first seemed a somewhat risky venture, has in the event proved most successful. While no cups or medals have been won, support given and the keen interest of players have indicated that the game has come to stay.

Though their first win was long in coming, the Club's team showed in the latter part of the season that they were as capable as any in the Association, which embraces Rotorua and Bay of Plenty. The Club had registered and played 31 players, a record playing membership for the Association.

Seventeen competition and friendly games were played, of which four were won, four drawn, and nine lost. Thirty-four goals were scored for the team and 18 against. Three Club players were selected for Bay of Plenty representative honours, and one of these, R. Alkema, goalkeeper, now appears to be the automatic choice of the Bay selectors for this position.

Club officials had found it difficult in deciding which of two players should receive the Norman Franklin Cup, awarded for the most improved player in 1956, but were agreed that it should go to R. Gurling. The second player mentioned was H. W. Matthews. Both players had improved greatly during the season and both possessed a great measure of team spirit.

A number of men employed by International Contractors, Wairakei, took part in the Club's activities during the latter part of the season, proving good sportsmen. It is planned to field teams from both Taupo and Wairakei in 1957.

The Club's thanks were due, states Mr Burge, to the Taupo District High School Committee for their permission to use the School playing area, for without this much appreciated co-operation the Club could not have continued to carry on. The Club president, Mr Fred Howes, had carried out duties far beyond those expected of the president, having undertaken the tasks of coach, goalkeeper and organiser, as well as the secretary's duties during the latter's absence undergoing medical treatment.

The publication of reports by the Taupo Times and Rotorua Post had been much appreciated, as it was realised by the most ardent soccer "fans" that at present the game was the Cinderella of sports in most localities. The published reports had proved of wide interest to followers of the game and had thus aided the Club in its first season.

SHRUBS.
HEDGING.
FRUIT TREES.

DAVID RILEY
HINEKURA AVE.

Phone 364.

FOR ALL CLASSES OF
DISPLAY, DECORATION
ADVERTISING
CRAFT

Consult **H. D. KING**

KAYDET KRAFT

ADVICE FREE.

P.O. Box
207.

Inqu
Phone

FOR THE JOB THAT

IS DONE

JUST SO MUCH BETTER

**MITCHELL
DUNCUM LTD.**

GARAGE & SERVICE STATION
RUAPEHU ST., TAUPO
The Home of Honest Repairs

TAUPO JOINERS LTD.
FLETCHER ST.

HIGH-CLASS JOINERY.
KITCHEN FITTINGS.
STANDARD SIZES GLASS
STOCK.

Ask Us to Quote for Your Job
Work.

Phones—Office and Factory:
After Hours: 552 S.

CASSON & CO. LTD.
FOR

DRAPERY.

PLASTIC MATERIAL in be
shades and designs; 36in.
At 3/9

TOWELS From 6

HIGH SCHOOL BLAZER
MATERIAL; 54in wide; MARO
Special Price: 9/6

HARDWARE.

TILLEY KEROSENE HEAT
economical and efficient.

PRESTO & PRESTIGE PRES
COOKERS.

TAUPO A.F.C. SENIOR TEAM 1956

THE FIRST TAUPO CLUB TEAM

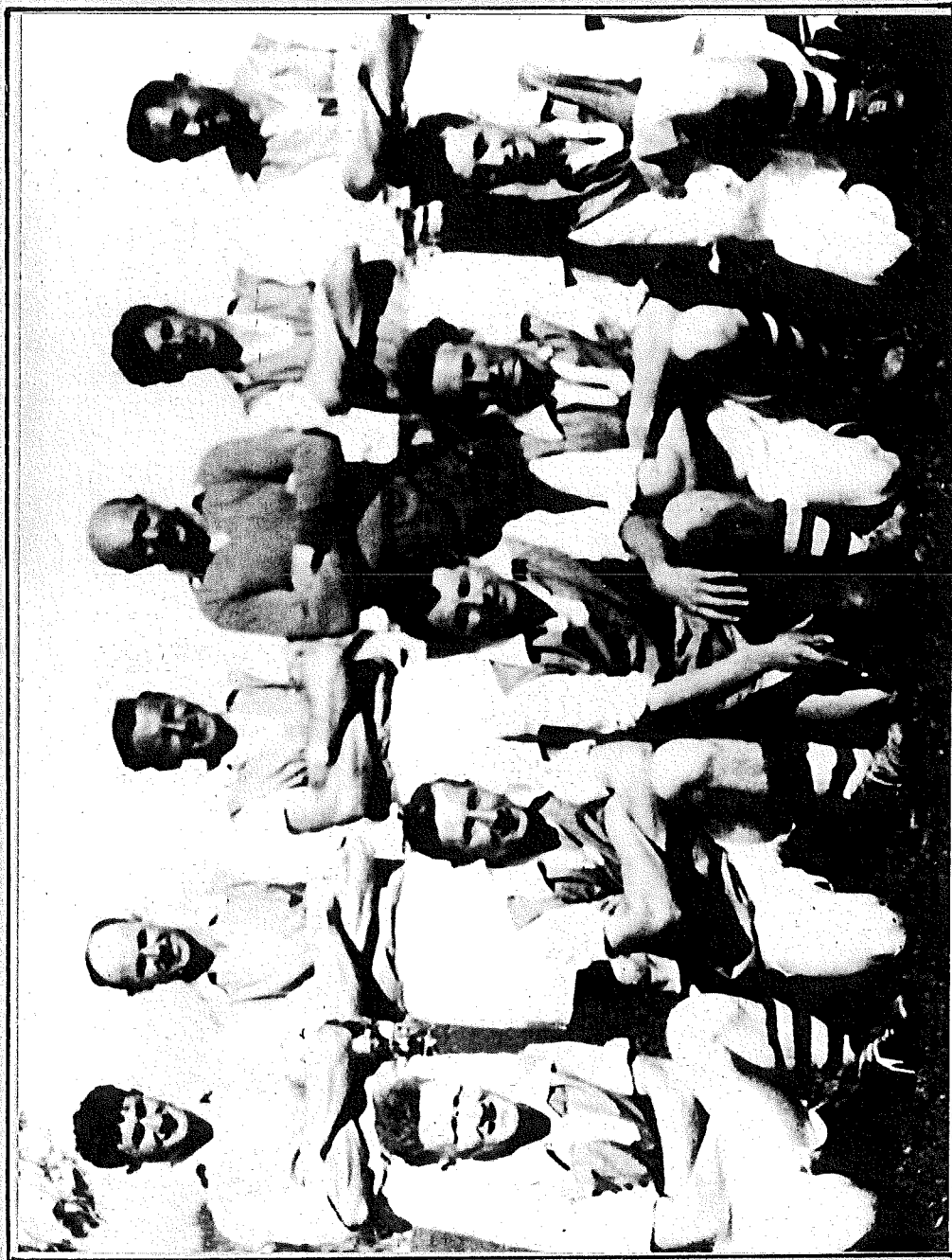

back row (left to right) : Phil Henry Bill Matthews Dick Arrowsmith Fred Howes Steve Kempton Arthur Yin
front row (left to right) : Trevor Drummond Joe Braddock L. Alkema Ron Girling (capt.) John 'Dutchy' Rademakers

1956 SEASON

BOP ROTORUA DIV 1956		P	W	D	L	F	A	Pts
Taupo United		8	2	1	5	11	29	5

Coach: Fred Howes

Team members:
 Alkema, R. (gk - former Dutch pro)

Braddock, Jimmy

Braddock, Joe

Doyle, T.

Drummond, Trevor

Fy, Peter

Girling, Ron (capt)

Harding, Bill

Harding, Ron

Henry, Phil

Howes, Fred

Imlah, G.

Jones, I.

Kempton, Steve

Marriatt, W.

Matthews, Bill

McKean, G.

McMahon, E

Millar, A.

Parker, Graham

Rademakers, John (Dutchy)

Robinson, A.

Schmidt, J.

Stebbing, John

Arrowsmith, Dick

Lysart, Jock

Storey, Jim Jnr.

Williams, Fred

Wood, Ken

Yin, Arthur

1956 SEASON

14-Apr-56	rot	Whakatane Town
28-Apr-56	a	Rotorua Caledonians
5-May-56	rot	Kawerau
12-May-56	a	Rotorua Crusaders
19-May-56	a	Rotorua Crusaders
26-May-56	a	Rotorua Rangers
16-Jun-56	h	Rotorua Crusaders
7-Jul-56	h	Kawerau
14-Jul-56	h	Rotorua Caledonians
4-Aug-56	h	Rotorua Rangers
5-Aug-56	h	Wairakei International Contractors
11-Aug-56	rot	Whakatane Town
18-Aug-56	h	Rotorua Crusaders
19-Aug-56	h	Wairakei International Contractors
25-Aug-56	h	Rotorua Caledonians
26-Aug-56	h	Wairakei International Contractors
1-Sep-56	a	Rotorua Rangers
16-Sep-56	h	Taupo Rugby Club

3 - 4 A. Millar 2, W. Harding jnr
 0 - 5

wbd
 first win
 friendly

1 - 4 Trevor Drummond

3 - 6 T. Doyle, W. Marriat, T. Drummond

0 - 0

1 - 7 T. Doyle

3 - 1 B. Braddock, Bill Matthews 2

3 - 6

2 - 0

3 - 2 I. Jones, Dutchy Rademakers, E. McMahon

2 - 2 Tai Mitchell Shield

3 - 6 Tai Mitchell Shield

draw

4 - 4

1 - 4 G. Parker

friendly

friendly

R. Alkema, T. Drummond, T. Doyle, A. Millar selected for rep trials in Rotorua
 R. Alkema selected as BOP rep goalkeeper

Referees:

1957

TAUPO UNITED

Work Wanted

(Continued from Page 11)

CARPENTER available, all types Building, Alterations, etc. Phone 285 R, P.O. Box 310.

CHIMNEY, Stove and Tank Cleaning. Orders being taken now. Busy Bee, Phone 336.

CLEARING, Ploughing or Leveling Sections, light tractor. Apply No. 347 Times.

HAVE your Home Decorated by O. K. Connor, Painter and Paperhanger. Workmanship guaranteed. Phone 474 Taupo.

SECTION Work, general clearing, etc. You quote. Box 287 Taupo.

TAUPO Driving School. Car if required. Success guaranteed. Instructor: Aubrey Dyke. For appointment telephone 306 M.

TYPIST, experienced, is prepared to undertake private work. Results guaranteed. Charges reasonable. Apply 66 Rifle Range Road.

£10 REWARD

For any Radio we can't repair. Ring 380.

RADIO SERVICE CO.,
TUWHARETOA ST.

We Collect and Deliver.

FIBROUS PLASTERING.
For all Fibrous Plastering and Gibraltar Board Stopping.

Immediate Attention.

B. GARLICK,
Phone 215 S.

PAINTING.

DECORATING.

PAPERHANGING.

By

EXPERIENCED TRADESMAN.

Free Quotes.

First-class Work Guaranteed.

APPLY TIMES OFFICE.

Accommodation

TONGA CABINS.

FLATS. CABINS.
BED AND BREAKFAST.

TONGA ST.
Phone 130.

For Hire

BOATS.
CABINS.
OUTBOARDS.
FISHING TACKLE.

Phone D. G. ERWING 312

Public Notice

TAUPO TIMES.

ANNUAL SUBSCRIPTION—

16/- Postage Paid.

Would Advertisers, Subscribers and Correspondents please note that the New Postal Address of the Taupo Times is P.O. Box 205 Taupo and that correspondence for this paper should be so addressed.

NEW ADDRESS.

R. K. M. MORTON, PLASTERER, is now residing at 25 ROTOKAWA ST.

TAUPO BADMINTON CLUB.

OPENING NIGHT.

The Fifth Season of the Taupo Badminton Club will open at the **WAR MEMORIAL HALL** on **TUESDAY, MARCH 12.**

Play will commence at 7 p.m. Members and intending members are invited to attend.

J. D. McLEOD, Hon. Secretary.

COMMUNITY ARTS SERVICE. TAUPO BRANCH.

Members' Subscriptions for the 1957 season are now due and may be paid to the Hon. Secretary, Mrs. Sutherland, the Hon. Treasurer, Mrs. N. D. Tilly, or at Harmony House.

J. SUTHERLAND,
Hon. Secretary.

TAUPO FOOTBALL CLUB.

The Annual General Meeting of the Taupo Football Club will be held at Rickit's Meeting Room on Thursday 14th March at 7.30 p.m. Present and intending members cordially invited to attend.

W. E. LEMBERG,
Hon. Secretary.

TAUPO UNITED ASSOCIATION FOOTBALL CLUB.

The Annual General Meeting of the Taupo United A.F.C. will be held at the School on Monday 11th March at 8 p.m.

AGENDA—

Annual Report and Balance-sheet. Election of Officers. General.

Present and intending members cordially invited to attend.

J. BURGE,
Hon. Secretary.

ARE YOU INSURED

IF NOT,

SEE THE ASHES OF MY HOUSE ON SPA ROAD AND SEE ME—

Public Notices

WAIKATO CHILDREN'S ATHLETIC CHAMPIONSHIPS.

HINEMOA PARK, HAMILTON.
10.30 a.m. **MARCH 16, 1957.**

Admission—2/-.

Hot Water on Ground.



TAUPO DRAMATIC SOCIETY.

MEMBERS' EVENING.

WEDNESDAY, MARCH 13.

THREE-ACT PLAY-READING.

"HOME AT SEVEN."

By R. C. Sheriff.

To be produced by Mrs. Yvonne West.

WAR MEMORIAL HALL SUPPER-ROOM. At 8 p.m.



AMBULANCE.

and

NURSING

DIVISIONS.

CLASSES WILL RECOMMENCE ON

MONDAY, MARCH 11,
IN RICKIT'S ROOMS, at 7.30 p.m.
Intending New Members kindly telephone 142 or 107 D.

TAUPO RUGBY SUB-UNION.
ANNUAL GENERAL MEETING of the Sub-Union will be held at the **TAUPO SCHOOL** on **SUNDAY, MARCH 17, at 2 p.m.**

AGENDA—

Annual Report and Balance-sheet. Election of Officers. General.
K. BOGUE, Hon. Secretary.

TAUPO BASKETBALL ASSOCIATION.

ANNUAL GENERAL MEETING of the Association will be held at **TAUPO SCHOOL** on **THURSDAY, MARCH 14, at 8 p.m.**

AGENDA—

Annual Report and Balance-sheet. Election of Officers. General.
Intending Members are especially invited to attend.
E. M. BIRNIE, Hon. Secretary.

DOMINION LIFE ASSURANCE.

Your Local Representative,
MR. S. L. GILKISON,
will attend to your needs.

For information about **MORTGAGE FINANCE, LIFE INSURANCE, ENDOWMENT INSURANCE,**
ring Mr. Gilkison at 605 D, or call at his Residence, Waihora Road.

GUN PRACTICE.

A Live Shell Practice will take place at Tihoi as follows:—
10th March 1957. Intermittent

For Sale

"EASYBUILT" Home Unit Furniture. Price Illustrated Catalogue: Howland and Son Ltd., Putaruru.

MATCHLESS and S. Shoes at the Taupo opposite P.O.

COSMETICS !! We range of all the leading for your convenience.

HANSBY'S PHARMA

SALE.

SAVE 20%.

8th to 15th MA

TAUPO BOOK

(Opposite School)

FANCY CORKS

And Sets of **COCKTA**

11/6 to 15/6

McCLURGS L.

JEWELLERS

For a Faster, Clean

PHILISHAVE DIF

With Triple H

The World's Best Elec

PRICE 12 GUIN

at the

TAUPO DRUG S

(Opposite P.O.)

SUN GLASSES !!

at popular prices. We

received some Night Dri

priced at 18/6.

HANSBY'S PHARMA

STEEL Office Equipm

Cabinets, Office Ch

available at **TAUPO ST**

(opposite Lake Hotel).

WHITE only, Sp

Cardigans, 20-22. Snow

matching Helmets, in as

and colours. New ran

and Towelling Feeders

Scarves and Squares just

good prices. New Sea

being opened frequent

Coats in very latest

shades.

NEWMAN & BO

LADIES !

We now have a full

CONTOURE COSM

REGENT BEAUTY

Phone 626.

HAND-CUT

BOHEMIAN CRY

UNITED SOCCER CLUB'S FIRST YEAR WAS SUCCESS

The annual general meeting of the Taupo United Association Football Club, held at the Taupo High School on March 11, was well attended. The chairman, Mr F. Howes, in his report said it was exactly a year to the day that the club was formed. It had enjoyed a successful first season, and there was every reason to believe the coming season would be even better.

One of the greatest difficulties of the previous season had been in finding a sufficient number of people willing to assist the organising side. Although there had been no shortage of players, at times the club was hard pressed to field a team, because of a large number of players required to work on various Saturdays.

Record Registrations

It was fortunate that a large number of men began work at Wairakei International Contractors, as many of them played in the later stages. They would be available in this season.

Last year 31 players were registered, a record for the association. A number were selected to represent the Bay of Plenty and R. Aikema was permanent Bay goalkeeper.

There was a long wait for the first match, but the club was holding its own against all teams in the later stages. A total of 16 games was played. There were four wins, four draws, and eight losses, goals for 34, against 48. The cup for the most improved player presented by Mr N. Franklin was won by R. Girling.

Improved Ground

One of the major difficulties at the moment was to obtain a suitable ground, but thanks to the Taupo High School committee, the club had been assured of the use of a ground for such time as one was provided by the Borough Council.

The ground was now greatly improved, and a higher standard of play should result in the coming season.

This year the intention was to enter for the Chatham Cup, the premier New Zealand competition. The club is presenting the balance sheet

the secretary, Mr J. L. Burge, stated that the club had no worries regarding finance; there was sufficient money to get off to a good start. All essential equipment had been purchased.

More money would be required, but the task would be easier than the previous year.

Members agreed to his suggestion that the membership fee be reduced from 30s to £1 year.

Election of Officers

Mr Burge said he would not be seeking re-election as secretary, but was prepared to continue working with the club.

The following officers were elected: Patron, Mr A. Kennedy; president, Mr F. Howes; vice-president, Mr J. L. Burge; honorary vice-presidents, Messrs J. Birnie, B. Baumberg, N. D. Tilley, Dr Richards, Rev. Father De Bree (all re-elected) and Messrs N. Franklin, H. Wolfe and C. Hutt; secretary-treasurer, Mr E. Fish; trustees, Messrs F. Howes and J. L. Burge; committee, Messrs P. Henry, M. McMahon, W. Taylor, H. W. Matthews, A. Yin, R. Aikema, T. Drummond; coaches, Messrs R. Girling and P. Henry.

The club would greatly appreciate the services of an ex-player with some knowledge of managing and training, this to be on a voluntary basis.

The club is affiliated to the Bay of Plenty Association, and competition matches will begin in mid-April.

Institute Gardeners Present Mrs King With Parting Gift

This month's meeting of the Taupo Countrywomen's Institute Gardening Circle was held at the Spa Hotel. Mrs J. Birnie was hostess. The meeting opened with the reading of the aspirations by Mrs J. Davis. Apologies were received from absent members.

Liliums and cacti were the main plants discussed, and an article in rooting cuttings in ground-up pumice was read by Mrs Davis. While the cuttings strike readily in ground-up pumice, a coarse grade with the addition of a little soil was thought to probably be a better mixture.

Its First Convenor

It was with regret that the circle

LAKE FRONT GARAGE LTD.

Phone 597.

Phone 597.

SERVICE STATION AND GARAGE

B.P. PETROL AND OIL.
ENERGOL GREASING SERVICE.

24-hour Breakdown Service.

BOATS FOR HIRE.

Taupo Agent for—

SEAGULL OUTBOARD MOTORS.

HARCO GAS
B.P. COMPROX
HOUSEHOLD DETERGENT

LIDGARDS FIBRE GLASS
COVERED BOATS

"LA GLORIA"

RECORDERGRAM

- • • FOUR SPEAKERS.
- • • TWO TONE CONTROLS.
- • • GREATER RECORD SPACE.
- • • FOUR-SPEED CHANGER PLUS MANUAL OPERATION.
- • • POPULAR-STYLED CABINET.

Tape Recorder can be withdrawn and used as a complete self-contained Portable Recorder or Playback Amplifier.

PLUS MANY OTHER FEATURES.

AVAILABLE AT

LOCKYERS (Taupo) LTD.

YOUR HOME APPLIANCE CENTRE.

CASSON & CO. LTD.

OFFER—

KNITTING WOOL.
KNITTING WOOL.
KNITTING WOOL.

The stocks of new season's just arrived.

Priced from 1/5 skein.

HARDWARE—

GARDEN SPADES. All Steel.
At 19/11 each.

MEL COVERED ROASTERS.
28/6.

ALUMINIUM RING MOULDS.
7/3.



BOILERS



TUBS

FIRTH

SIX SENIOR FOOTBALL TEAMS THIS SEASON

There will be six senior Rugby teams in the Taupo sub-union's competition this season, following the decision by Tongariro not to form a sub-union of its own, through lack of support from Taurewa, it was reported to a meeting of the management committee.

The teams will be Tongariro, Taupo, College Old Boys, United, Wairakei, and a combination of Oruanui and Atiamuri State hydro camp.

Five junior teams have been nominated—College Old Boys, Maroa, Taupo, Tongariro and United.

New Fifth Grade

This season a new grade, fifths, come into the football picture, and Taupo District High School has nominated four teams. For this grade there is a weight-limit of 10 stone, and players must be under 17 years of age.

Mr N. D. Tilley was elected chairman of the management committee. Selectors will be Mr D. Tatana (senior) for the fourth time, and Mr T. Keehan (junior).

Saturday, April 27, will be opening day.

The Taupo club members moved that the knockout competition should be played at the beginning of the season. They said it, (a) gave club teams time to organise and to arrange teams; (b) any club which entered late did not interfere with the main competition, and (c) there would not be any tailing-off at the end of the season, as there had been in the knockout.

As a consequence, they argued, the final representative match did not suffer through lack of fit players.

Mr T. Kohika (College Old Boys) moved an amendment to retain the

established system, which he said was followed by Wellington, Auckland, Hawke's Bay and others, who played their knockout competitions at the end of the season.

There was a seven-all tie on the voting, and the acting-chairman, Mr B. J. Baumberg, cast his vote against the amendment, which was lost.

The original motion was then put, and again there was a seven-all tie. As a sporting gesture a coin was tossed; and the knockout competition will be played at the end of the season.

GOOD START FOR SEASON BY SOCCER CLUB

According to Mr F. Howes, president of the Taupo United Association Football Club, the club has started off the new season in good style. Training has begun, and already three trial games have been played.

No difficulty was met in fielding two teams from among club members, he said.

"Unfortunately, competition games interfere with the working hours of the majority of members, so the club will welcome any new members who have their Saturdays to themselves," he continued.

There is to be a friendly game against the Caledonians at Rotorua next Sunday, April 14. He expects this game to be noted with interest by Rotorua followers of soccer, who are watching the progress of the game here.

Mr J. A. Fenton has donated a cup, and it was decided at the last club meeting that the cup should be the trophy for a series of five games against an International Contractors team each year.

Rotorua junior teams have challenged a Taupo junior team now in the process of formation, and have offered to play at Taupo.

ROSS SHIELD CAPS

Ross Shield caps will be bought by the Taupo Rugby Sub-Union this year. The management committee has decided also to give a ball subsidy to every school which applies for it, to a maximum of £1 5s for each school.

New Gendarme Song

The French National Security Police Force has been endowed with a new anthem called "Police de France."

The anthem is part of a drive to make the French police more popular prestige is low at the moment, partly because of rivalry between various forces, and partly because of over-generous use of their white truncheons.

The Minister of the Interior Gil-

OPTICIAN

G. T. A. McCLELLAND
F.S.M.C. (London)

VISITS TAUPO ON APRIL 17.

For Appointments Ring
MR. G. FRASER, CHEMIST, TAUPO,
Phone 140 M.

POPULAR RECORDS

HARMONY HOUSE

Latest Popular Records

JUST ARRIVED



Elvis Presley ROCK 'N'
78-r.p.m.'s as well as 45

BILL HALEY AND HIS COMETS.
DAPHNE WALKER.

THE PI
BILL WOLFG

HAWAIIAN HARMONIES.

Come and Inspect Our Long-playing CLASSICAL

Materials - Building

Stocks of All Building Materials and Hardware
Gibraltar Board, Pinex Hardboard, Mouldings,
Spoutings, Ridging, Roofing, Downpipe, Wire
ing, Nails.

FIBROLITE MOULDINGS, FIBROLITE, DUROID,
PAPER, etc.

CHIMNEYS—Open Fire and Kitchen, Single or Pa
SURROUNDS—Tile, Terrazzo or Concrete.

BOILERS—12 to 20 gallons.

WASH TUBS—Single, Two or Three Compartments.

FOUNDATION PILES. CONCRETE POSTS.

AIR VENTS. STRAINERS AND

BUILDING BLOCKS (Vibrapac and Vibrabloc).

E.W. PIPES & FITTINGS. DUROCK SIDINGS. FIB

CONCRETE PIPES—9in to 36in.

BRICKS—Fancy Surround, Facing, Red, Huntly, Fireb

TILES—Flooring Red and Cream, Glazed Hearth, Glaze

Wall.

GATES—Hurricane Wrought Iron. H.R.C. Mesh.

FLUSH DOORS—Coreboard. Mouldings.

SOFONO HEATERS.

PALLO WASHING MACHINES.

PREFABRICATED STEEL BUILDINGS.

ANVIL PAINTS. NECO LOUVRES.

Complete House Lots Native Timber.

W. L. FULLJAMES

RUAPEHU ST., TAUPO.

Phones: 104 S Business. 104 M Residence

SALVAGE & RECOVERIES LTD.

Cash Buyers of—
BOTTLES,
SACKS,
METALS, Etc.

We Call and Collect.

Ring 418 Taupo.

TAUPO JOINERS LTD.
FLETCHER ST.

7 - TON AUSTRALIAN

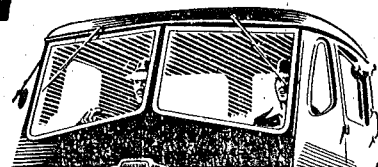

HOME BUILDERS

LET ME QUOTE YOU FOR YOUR
NEW HOME OR BACH

EXTENSIVE MACHINERY AND EXPERIENCE
TO GUARANTEE A
PROMPT AND FIRST-CLASS JOB.

K. A. WILSON

HILLTOP ROAD, TAUPŌ.

Phone 570 K.

VAUXHALL BEDFORD CHEVROLET

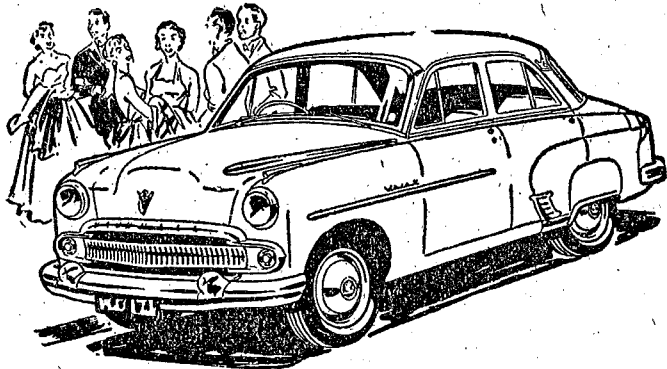

USED VAUXHALLS

SEVERAL 1954-1955 MODELS
TO CHOOSE FROM.

NEW BEDFORD TRUCKS

3-ton, 5-ton and 7-ton
MODELS

Now Available For Immediate Delivery.

NEW VAUXHALLS EARLY DELIVERY ON STERLING FUNDS.

FOR FULL PARTICULARS ENQUIRE AT

R. M. Taupo Ltd.

TONGARIRO ST., TAUPŌ.

Phone 557.

Distributors

VAUXHALL — BEDFORD — CHEVROLET.

CONCRETE EVIDENCE

of perfection
is shown in this
reinforced pumice chimney

TAUPO SOCCER TEAM BEAT ROTORUA TWO-NIL

A friendly soccer match between Taupo United and Rotorua Crusaders was played at Rotorua last Monday. Taupo won two-nil.

Both teams were weakened by holiday absentees, but despite this a very close game was played. Taupo kicked off, and all through the first half showed their superiority but could not find the net. Several good attempts were stopped by the Crusaders' goalkeeper, but half time found no score.

In the second half the Taupo skipper made a few changes in the line-up which soon paid dividends, with F. Howes scoring a goal shortly afterwards.

Crusaders rallied with some good football after this setback but the Taupo defence stood up quite well, and H. Stagg, the Taupo goalkeeper, made some good saves.

Taupo once again pressed on, and after some good mid-field play by R. Alkema and P. Henery, F. Howes went through to score again, making the score two-nil.

Crusaders tried hard, but after the Taupo custodian had saved a penalty kick the game was in the bag for Taupo.

Tomorrow Taupo meet last season's champions, Rotorua Rangers at Taupo.

Just In Case Panama Tries A "Suez"

These are anxious days for a man in the Pentagon — General Robert M. Montague, U.S. Commander-in-Chief, Caribbean. His worry: Panama Canal could be nationalised as easily as Suez.

General Montague's preparations for an elaborate exercise aiming at the "protection" of the Panama Canal, are being watched anxiously by American military leaders.

No fewer than 10,000 men from the Army, Navy, Marines and Air Force will take part in this exercise — the first of its kind for many years.

The move has political significance, because Nasser's success in Suez has encouraged Panama's dynamic dictator, President Ernesto de Laguardia, to make a strong stand on Panama's canal claims.

He has already sounded out American officials about following Nasser's lead and nationalising Panama's waterway.

The Panama canal is owned by the United States, which pays Panama \$858,000 a year for the right of way.

De Laguardia has hinted that he might bring up the issue in the United Nations.

Russia's Support

This would be a tricky one for

R. DAWSON,
LICENSED DRAINLAY
SEPTIC TANKS. DRA
SOAK HOLES.
Estimates Free.
TAMATEA AVENUE
Phone 317 R.

ORDER NOW!
SHRUBS. FRUIT TREES.

For delivery from May
New Season's BULBS now i
WREATHS, WEDDING BOU
and all FLORAL REQUIREME
Bonded Member "Interfl

PETITE FLEUR FLORI
A. E. & M. F. BALL, Pro
ON THE LAKE FRO
Phone 637.

KENT'S LAND AGENCY

L. E. PEARSE,

LICENSED LAND AGENT

WE ARE AGENTS FOR I
HOUSES.

£2150. Snip of the week
three-bedroomed House all
close to lake and townsh
locality, on Section worth £6
is the best buy on our boo
£2400. First time on market
two-bedroom Home. Well
grounds, concrete paths.
water area. Garage under
View of lake and mountain
four years, best materials.
tric. Flush toilet.

£2325 Cash or £400 Deposit
3-bedroom Home, handy to t
road, to school and township
Section. Electric. Nice s
livingroom, kitchen with fu
bathroom, hot and cold wat
wash basin and flush toilet.
an ideal home for someone
£400. Immediate possession.

£6500. Beautiful 4-bedroom
nearly new, double-storeyed,
residential part of Taupo,
town, all first-grade floor c
Venetian blinds and hangin
property is ideally suited
doctor's residence or pro
man's home. All inquiries
confidence.

KENT'S LAND AGEN
L. E. PEARSE.

Phones: Office 495. Residen
Ces. Badeley
Gordon MacDonell

WE SELL FARMS



TAUPO ELECTRICITY COMMITTEE TO HEAR A DEPUTATION ON POWER QUESTIONS

ON of the Tauhara township with electric power before the Taupo Borough Council last week. After considerable discussion, the council decided a committee would be willing to meet a deputation of Tauhara Residents Progressive Association and would be connected "as soon as possible."

The association's chairman, Mr. Williams, is concerned with the matter, Mr. J. E. Williams on the subject of the meeting is letter did position ade-

Times last week. The Tauhara residents' resolution: "That the council be requested to appoint a deputation to attend the meeting on the subject of power supply covering the present position."

The council meeting on the electricity supply was attended by some of the town clerk, Mr. Williams.

about power supply in the Tauhara," he said. "The impression is that some of the supply is being used for anything at

were very much to be given priority, but I view that it will have pri-

see what loan-money; it is a question of supply. You sort of argu-

to follow the council about loan-money about something about the situation.

some time ago they had them that application, permission to pay.

power was available, to connect the houses there.

Cr C. S. Currie seconded the motion, which was subsequently passed. The town clerk told the meeting there were 25 houses involved.

Want The Facts

Cr Sefton suggested that when Taupo had an augmented supply, and the winter was more or less gone, it should be possible to give the Tauhara people power governed by a current-limiter at each house, to give them lighting only.

"A lot of people there are not concerned with cooking or water-heating," he added, "but want power just for lighting purposes."

Cr Currie said the electricity committee could go into that.

Cr J. E. Barton suggested that the Tauhara people should be supplied with a full categorical statement, as they asked. "They apparently think they have not the full facts," he said. "It has been rather side-tracked."

The Mayor: It isn't a matter of loan-money; I can't see how it affects them.

Cr Barton: I think that if they had a statement, they would not go on

TURNING FIRST SOD FOR WATER

ANOTHER page in Taupo's history was turned last Monday morning when the Mayor, Mr. J. E. Story, at the controls of a carryall on a fern-covered area at the top of Hinekura Avenue, cut a swathe where in a few months will rest the water reservoir.

Interested spectators were Messrs J. D. Swan, C. J. Vedder and K. E. Young, all former councillors, and Mr. K. M. Butt, principal of the Butt Construction Company, Ltd., of Taihape, which has the contract to build the reservoir, booster-house, pumping-house, and the pipeline running into the lake.

Mr Story said afterward the council had every reason to believe that reticulation would be continuous throughout the town. The scheme should be finished in two years.

"It was unfortunate that they were under the axe when it dropped, and we could not put any more on to the power supply. I believe that when power is available, the three or four permanent residents should be connected at the earliest possible moment.

"I don't think we can carry it any further than that."

Prior Approaches

Cr Sefton: Is it a fact that they made approaches before Hatepe, and Acacia Bay?

The Mayor: I couldn't tell you that.

The town clerk: Individual applications were made some two or three years ago, but not as a body. We have not had any correspondence on our files since October of last year. It was lack of organisation.

Cr Barton: Those are the sort of things that should be supplied officially; dates they made application, and the dates that other people with organisation made application.

"They have asked for something, and I don't see why they shouldn't have it. We shouldn't ignore a definite application."

The council then decided, on Cr Sefton's suggestion, to invite a Tauhara deputation to wait upon the electricity committee.

KEEN COMPETITION FOR GOLF KNOCKOUT

The first round of the patron's trophy, a mixed fourball bestball knockout, was keenly attended last Saturday, 17 couples contesting the first round.

Results, with winners named first: Mrs Hullten and R. Ellis v. Miss J. Armstrong and E. J. Ryan; Mrs Thomas and G. Thomas v. Miss B. Bolton and L. Holdsworth; Mr and Mrs Cheal v. Mrs B. Bennett and G. Barlow; Mr and Mrs Foote v. Miss R. Payne and G. MacDonnell; Mr and Mrs Colson v. Mr and Mrs Watson; Miss Watson and E. M. Smith v. Mrs Pearce and N. Kerr; Mr and Mrs Young v. Miss Branson and A. L. Graham; Mr and Mrs Fearn v. Mrs Logan and F. Sherning; Mrs N. Irvine and T. O'Neill, a bye.

A stableford competition run for unattached men was won by G. Comer with a total of 35 points.

Sunday saw the arrival of a Putaruru team to compete with the club in the first round of the Ewert Shield, the match resulting in a close lead for Taupo. The second and final round will be played on the Putaruru club's course later in the season.

Taupo Team Goes Down In First Soccer Game

Taupo was beaten by three goals to one in the first soccer game of the season when they met Rotorua Rangers at home last Saturday.

Rangers showed the form which won them the honours last season, but Taupo's performance indicated that Rangers will have to work hard for the title this year.

Despite the two-goal lead, throughout most of the game Rangers were on the defensive. It was only the indifferent finish among the Taupo forwards which caused the team's defeat.

Full honours must go to the Taupo defence, which showed signs of becoming a formidable combination, and to G. Parker for his goal of the match.

To-morrow, Taupo meets Caledonians at Rotorua.

Last Sunday Taupo met International Contractors in the first game of the series for the Fenton Cup, and lost 12-5. It was Contractors first victory.

Taupo was unfortunate enough to play a man short, which proved too much, especially after the game the day before, for some of the older members. The club says it would welcome any new players.

Mrs Fearn, Mrs Hamilton lost to Mrs Hullten, Mrs Halkett beat Mrs Young, Mrs Martin lost to Mrs Watson.

The second round of the two-lifer competition played by the ladies' club resulted as follows: Mrs Barrell beat Mrs Pearce, Mrs Fearn beat Mrs Barton, Mrs Watson beat Mrs Hullten, Mrs Thomas beat Mrs Young, Mrs Foote beat Mrs Colbeck, Mrs Irvine beat Miss Branson, Mrs Nelson beat Mrs Colson.

Good Hockey Seen In Preliminary Games Of Season

The Taupo Hockey Association opened the season last Saturday with two practice games. They were played on the same ground as last year, as no suitable alternative is yet available for match play.

A good attendance marked the day, though only United (women's) fielded a full team. As is usual on the first day, a few individuals shone and teamwork was remarkable by its absence.

It was pleasing to note that all

GLANKE'S

DRINKS & CORDIALS

HOW OBTAINABLE FROM
OUR DEPOT—
PIHANGA ST., TAUPO

Phone 540.

PAINTING
TERIOR AND EXTERIOR
DECORATING

Your Home, Shop or Office
Expertly Decorated by

N DRUMMOND & SON

ates Free. Moderate Charges.

NEMOA AVENUE, TAUPO.
Phone 264 K.

SUBURBAN SERVICE STORE.
CERY. DAIRY.

FROZEN FOODS.
SH FRUIT & VEGETABLES.
FREE DELIVERY.
ad and Paper Orders Taken.

FORD'S GROCERY

AND DAIRY.

An I.G.A. Store.

ER RIFLE RANGE ROAD.
Phone 634 K.

"LOOK"

SUNRIPE CAKE MIXTURE.

Usually 3/2.

Now 2/10.

FREE DELIVERY.

grocery. Frozen Foods.
resh Fruit and Vegetables.
id and Paper Orders Taken.

MUNN'S MARKET

(An. I.G.A. Store).

RIFLE RANGE ROAD.

Phone 165.

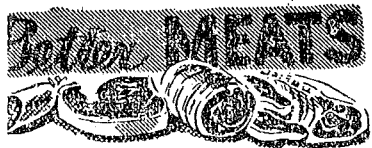

From

IAWKE'S BAY PASTURES.

UPO MEAT SUPPLY LTD.

E. T. SMITH, MANAGER.

POSITE THE POST OFFICE.

Phone 427.

Peacocke (skip), Mrs. C. J. Banks
(third), Mrs. A. R. Pearse (No. 2),
Mrs. J. B. Stephens (lead).

Champion pairs, Peacocke Cup
and Bars: Mrs. F. Fletcher (skip),
Mrs. J. B. Stephens (lead).

Cowan Lewis Silver Vase,
first-year and second-year singles:
Mrs. J. B. Stephens.

Tong Gold Buttons, progressive
pairs: Mrs. K. McMillan and Mrs.
J. B. Stephens.

McMillan Buttons: Mrs. H. J.
Peacocke (skip), Mrs. J. Marett
(third), Mrs. C. Christensen (No. 2),
Mrs. J. B. Stephens (lead).

Crickett Crystal Trophy, pairs:
Mrs. R. McMillan and Mrs. W.
Harris.

Story Crystal Trophy, handicap
singles: Mrs. C. Christensen.

McIsaac and Christensen Trophies,
handicap singles, Mrs. V. Simpson;
runner-up, Mrs. W. Prosser.

Aggregate progressive pairs for
season: Mrs. J. Wright; consolation,
Mrs. R. F. Houghton.

Mrs. C. Christensen, the first-year
champion, also won the champion
of champions competition of Bay of
Plenty.

During the afternoon a rinks
contest was won by Mrs. H. J.
Peacocke (skip), Mrs. N. Simpson
(third), Mrs. G. Chase (No. 2) and
Mrs. D. Roughsedge (lead).

TAUPO SOCCER LOSS BY POINT AGAINST ROTORUA CRUSADERS

Taupo United lost by three goals
to two against Crusaders at Rotorua
last Saturday, in a game played
under adverse weather conditions.

Taupo lost the toss and kicked off
against a strong wind and blinding
rain. After several good saves, the
Taupo goalkeeper, H. Stagg, was
caught unsighted to give Crusaders
their first goal.

Shortly afterward, a pass back to
the goalkeeper was handled by a fel-
low defender, and a penalty kick
awarded. Crusaders made no mis-
take with a well-placed shot into the
corner of the net.

Some Good Football

Despite the elements, Taupo went
into the attack, and J. Walpole, scor-
ed their first goal from a cross-kick
from the wing, making the half-time
score 2-1.

The second half saw an improve-
ment in the weather, and Taupo was
soon off to the attack. After several
near-misses, T. Drummond scored an
equalising goal for Taupo with a
good hard shot. Crusaders were not
daunted by the setback. They
settled down to some good football,
and were rewarded with a winning
goal before the final whistle.

Three Taupo players were select-
ed for the association to play the
visiting Gisborne team — H. Stagg,
R. Girling, and W. Matthews.

Taupo Times 10/5/57

17 JEWELS Value!



The special
Pierpont Time-
master — famed
for accurate and
reliable timekeep-
ing—the finest in
SWISS watch
making.

McCLURGS LTD.

JEWELLERS.

TONGARIRO ST., TAUPO.

Phone

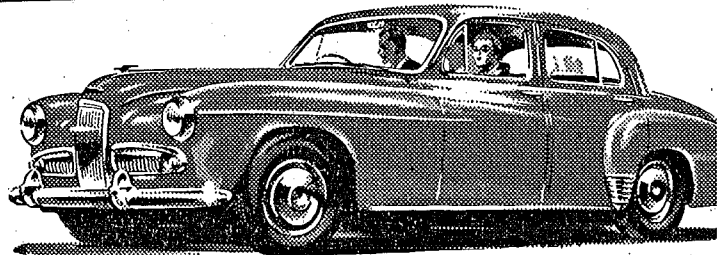

We wish to announce that we have a
HUMBER SUPER SNIPE

arriving shortly, this car being available for immediate deliv

This is a rare opportunity to purchase a High-class
at only £1366.

For Further Information Call In and See Us Without Obliga

CRYER MOTORS LTD.

TAUPO.

Telephone 467.

Box

Materials - Building

Stocks of All Building Materials and Hardw
Gibraltar Board, Pinex Hardboard, Mouldi
Spoutings, Ridging, Roofing, Downpipe, Wire N
ing, Nails.

FIBROLITE MOULDINGS, FIBROLITE, DUROID, BUIL
PAPER, etc.

CHIMNEYS—Open Fire and Kitchen, Single or Parallel
SURROUNDS—Tile, Terrazzo or Concrete.

BOILERS—12 to 20 gallons.

WASH TUBS—Single, Two or Three Compartments.

FOUNDATION PILES. CONCRETE POSTS.

AIR VENTS. STRAINERS AND FOOTI

BUILDING BLOCKS (Vibrapac and Vibrabloc).

E.W. PIPES & FITTINGS. DUROCK SIDINGS. FIELD T

CONCRETE PIPES—9in to 36in.

BRICKS—Fancy Surround, Facing, Red, Huntly, Firebrick.

TILES—Flooring Red and Cream, Glazed Hearth, Glazed Floo

Wall.

GATES—Hurricane Wrought Iron. H.R.C. Mesh.

FLUSH DOORS—Coreboard. Mouldings.

SOFONO HEATERS.

PALLO WASHING MACHINES.

PREFABRICATED STEEL BUILDINGS.

ANVIL PAINTS. NECO LOUVRES.

Complete House Lots Native Timber.

W. L. FULLJAMES

RUAPEHU ST., TAUPO.

Phones: 104 S Business. 104 M Residence.

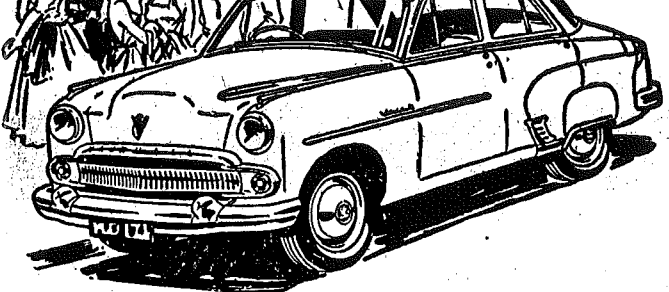

USED VAUXHALLS

SEVERAL 1954-1955 MODELS TO CHOOSE FROM.

NEW BEDFORD TRUCKS

3-ton, 5-ton and 7-ton MODELS

Now Available For Immediate Delivery.

VAUXHALLS EARLY DELIVERY ON STERLING FUNDS.

FOR FULL PARTICULARS ENQUIRE AT

R. M. Taupo Ltd.

TONGARIRO ST., TAUPO. Phone 557.

SALE AGENTS: VAUXHALL — BEDFORD — CHEVROLET.

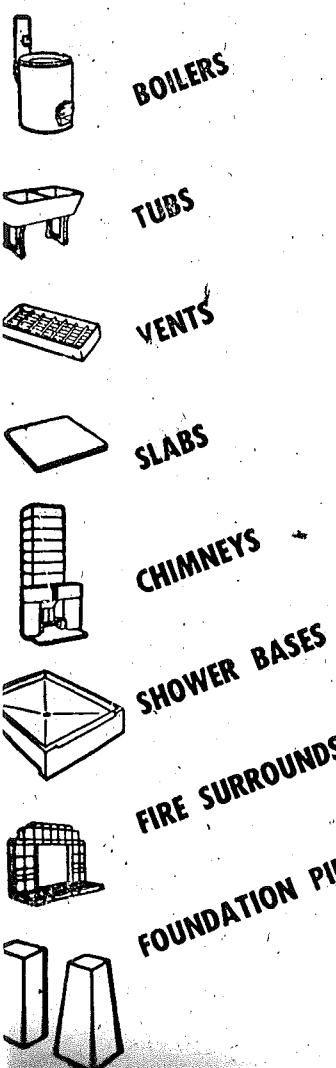

FIRTH CONCRETE LTD

- Frankton
- Rotorua
- Stratford
- Hastings
- Putaruru

Sole Agents: W. L. FULLJAMES, Phone 104.

season's racing on a high note. He won three good races on end—the York Handicap at Ellerslie, and the Whyte Handicap and Onslow Handicap, both at Trentham. In the Whyte he carried 9.12 and won by four lengths, while in the Onslow Handicap he had three lengths to spare from Fir Bolgs and Ngatoki, despite his staid of 10.8.

When Peter Willonyx parades at Te Rapa to-morrow he will be ridden by J. H. Hely—his regular jockey until the latter's disqualification nearly two years ago.

Anyhow showed his class in winning the Stewards Handicap last week by a length and a half from Sir Valley, with Domitare a similar distance further back. It was not until the field was nearing the straight that Anyhow began his run from the back, but he was well in command in the last furlong and won convincingly.

Improvers in Otara, Peterford, Trench Light, Turkman, Arva and Britannia's Song should lend interest to what promises to be a fine contest.

There are 14 acceptors for the Tyler Memorial Handicap, second leg of the double, for which the Rotorua winner, Mangatoki, is fancied. However, he may encounter stiff opposition from Drumawhey and New York, last week's bracketed winners of the President's Handicap.

Selections:

TE RAPA

- RAGLAN PLATE: Gariand Gold, Ascot Beau, Manus.
- WINTER HACK HURDLES: Meresun, Lochgair, Levanto.
- PARANA HACK HANDICAP: Robert Kay, Sir Goodwin, Akenehi.
- FLYING MILE HANDICAP: Peter Willonyx, Anyhow, Otara.
- CLARKIN STEEPLES: Knight's Star, Pad, Swelter.
- TYLER MEMORIAL HANDICAP: Mangatoki, Drumawhey, New York.
- MANNING HACK HANDICAP: Summer Girl, Whittora, Lady Janice.
- FAREWELL HACK HANDICAP: Archdeacon, Richard Chappell, Indelible.

POVERTY BAY

- WAINUI HACK HURDLES: Twister, Orawai, Mozart.
- FIRST MATEWHERO NOVICE STAKES: Liono, Five Crowns, Prince Bon.
- SECOND MATEWHERO NOVICE STAKES: ROZALE, Shindig, Sherwood Prince.
- TE HAPARA HANDICAP: Great Scot, Kaha, Prince Bayanut.
- GISBORNE STEEPLES: Prone, Glenone, Jewel Denby.
- PUBLICAN'S PURSE: Our Belle, Shiralee, Qantas.
- WAIPAO HACK HANDICAP: Triple Chance, Rawera, Bookful.
- KAITI HACK HANDICAP: Scapula, Merry Jester, High Fidelity.

Chateau, Gay Lodge.
FIRST HIMATANGI HACK HANDICAP: King's Rule, Gold Pe, Leon Libeau.
KEBBELL MEMORIAL HANDICAP: Golden Roll, Monogr, Bugle Boy.
MOUTOA HACK HANDICAP, 2nd division: Panseron, Golden Sp, dour, Quicksand; second division: Lucky Arch, Caribbean Gold, O, Heart.
SECOND HIMATANGI HANDICAP: Magic Lad, Nova Stello, Jub, Rag.

TAUPO UNITED HAS FIRST VICTORY, HENRY'S HAT-TRICK

Taupo United beat Rotorua Caledonians 4-2 in a soccer match played on the High School grounds last Saturday under ideal conditions. They were the first points gained by the local club this season. Their inside right, P. Henry, scored three of the four goals.

Caledonians began to attack from the start, and for the first 10 minutes Taupo was on the defence. Again the run of play the local forwards gained possession, split open the Caledonian defence, and Henry scored.

The early reverse stung the visitors, and five minutes later the Taupo goalkeeper, F. Howes, was beaten by a first-time shot from opposition right-half, H. Wys, to equalise the score.

Most of the play was now in the middle field, and there was little to choose between the two teams.

At the 31st minute of play, following an infringement in the Taupo penalty area, Taupo was unlucky not to score from a spot kick by right-half R. Alkema, the ball striking the crossbar.

Much Improved Team

Play swung from end to end, Howes was called upon to save several hard shots from the Caledonian forwards. After 40 minutes, Henry took the opposition with a hard goal shot, to put Taupo once again in front. A minute before the interval H. Hansen, Caledonian outside-right, put one out of reach of the Taupo goalkeeper. Half-time score: Taupo 2, Caledonians 2.

Upon resumption Caledonians attacked vigorously, but lacked finish in front of goal. After 10 minutes Taupo took control of the game, and much the better of exchanges. Henry scored another goal, and J. Smith added one more. J. Smith

Taupo showed itself as a greatly improved team.

To-morrow's match is against the Rotorua Rangers at Rotorua.

rua
ford
ings
ruru

TAUPO AGENT: W. L. FULLJAMES.

A very enjoyable day's golf resulted, despite the odd showers that the Taihape players brought with them, resulting in a win for the local team. Results, Taihape names first, were as follows:

Mrs McKee beat Mrs Thomas, Mrs Sinclair lost to Mrs Fearn, Mrs Archer lost to Mrs Hultten, Mrs Somerville lost to Mrs Bennett, Mrs Cozens lost to Mrs Colbeck, Mrs Hintz drew with Mrs Young, Mrs Hilton beat Mrs Watson, Mrs Mortland lost to Mrs Colson, Mrs Naylor

heavy rain. This Saturday's competition will be a stableford.

Soccer

TAUPO DOWNS TOP ROTORUA SOCCER TEAM

Taupo United soccer team beat Rotorua Rangers 3-2 at the high school grounds last Saturday, in a first-round match for the Chatham Cup. It was a meritorious win, since Rangers were last season's champions in the Bay of Plenty, and previously undefeated this season.

They won the toss, and began with a strong breeze behind them. For the greater part of the first half, Taupo was kept busy, repelling the Rangers' forwards, but gave them little chance of shooting for goal.

Two Quick Goals

After 40 minutes the local team, which improved as the game progressed, carried the attack to their opponents.

At the 43rd minute, after neat passing, outside-right Shepherd beat Rangers' goalkeeper with a hard shot.

A minute later, Rangers capped a strong attack with an equalising goal. Play was then even.

Shortly afterward the Taupo forwards combined well and gave Farrell the opportunity of again putting Taupo in front. Half-time score: Taupo 2, Rangers 1.

Immediately after the resumption, Rangers' forwards carried the attack to the Taupo goalmouth. That was followed by an infringement in the penalty area by a Taupo defender, and the referee awarded a penalty to Rangers.

The spot kick by a Rangers' forward had the local goalkeeper well beaten, and the teams were level with the score at two-all.

Rangers On Defence

Two minutes later, Taupo again put themselves in the lead, a Taupo forward finding the net after the ball had struck the crossbar and rebounded into play.

For the remainder of the game Rangers were mostly on the defensive.

The Taupo team, as it did on the previous Saturday, appeared to improve as the game developed. However, the Rangers' defence, though hard-pressed, prevented the Taupo forwards from increasing their lead.

To-morrow's match will be against Rotorua Crusaders at Taupo.

It will soon be here . . . the new
VAUXHALL VICTOR



If you can obtain a non-remitting licence you'll be sure of a "Victor" the wonderful new Vauxhall Victor has taken England by storm . . . demand in New Zealand will be high, and supplies will be limited. A non-remitting licence can make certain of a new Vauxhall Victor for you.

This is how you qualify

If you have £320 sterling or the equivalent in overseas funds or securities (Held prior to 18th November, 1953) or funds obtained at any time from legacies, benefits from estates, trust funds, or money accrued from salary or wages earned out of New Zealand —call in and see your nearest Vauxhall dealer for information on how to secure an import licence.

If you are visiting Britain for a year or less, you may purchase your new Vauxhall while there. Delivery can be made anywhere in the British Isles, and when your visit is over your Vauxhall can be shipped back to New Zealand. Your Vauxhall dealer will be glad to explain the details of this plan to you.



SEE YOUR VAUXHALL DEALER
VAUXHALL

M Distributed by General Motors New Zealand Limited through:—

R. M. (TAUPO) LTD.
Tongariro St., Taupo

TAUPO CAR SALES

Dealers have Cars to suit every man's pocket with their confidential easy terms.

winter's coming on it will pay you to come and talk it over.

also buy your car, trade it in, or sell it on your behalf.

You're under no obligation whatsoever.

Phone 645 D TAUPO.

Thirty Vehicles always in stock.

TAUPO SOCCER TEAM LOST BY ONLY ONE POINT IN BAY CHATHAM CUP FINAL

Kawerau beat Taupo 6-5 in the Bay of Plenty area final of the Chatham Cup match held at the Kuirau Reserve, Rotorua, last Saturday. There was little to choose between the two teams, and the general standard of play was excellent.

There was a cup-tie flavour about the match, and both teams played with vigour, play swinging from end to end; there was little midfield play. The early exchanges were slightly in favour of Kawerau.

At the 12th minute, following an infringement in the Taupo penalty area, the referee, Mr A. Fields, of

Rotorua, awarded a penalty to Kawerau, and F. Fonville, Kawerau's inside-left, made no mistake.

Two minutes later the Taupo centre-forward, E. Farrell, shot a hard one past the Kawerau goalkeeper, and the teams were level. Taupo continued to have the better of exchanges, and at the 17th minute were leading 2-1, G. Parker scoring after good combination by the forwards.

Rapid Scoring

Thirteen minutes later Farrell again scored, making the score 3-1 in Taupo's favour, but within the next four minutes no fewer than three goals were scored.

Kawerau attacked resolutely, caught Taupo defence off-balance, and T. Celie capped it by heading a hot one to the back of the net past H. Stagg, the Taupo goalie.

Kawerau pressed again, and obstruction by a Taupo player in the penalty area gave F. Fonville, Kawerau's inside-left, an opportunity of which he took full advantage, and his spot kick made the scores even.

At the 34th minute Taupo took the lead when inside-right R. Alkema netted. A few minutes before the interval the Kawerau centre-forward, T. Celie, scored his second goal, and the teams were once again at level pegging.

Unnecessary penalties

After six minutes in the second half, Celie scored his third goal for Kawerau, and shortly after the Taupo centre-forward, Farrell, did the same for Taupo, making the score five-all.

A few minutes later R. Perkinson, Kawerau outside-left, scored the finest goal of the match when he headed in from several yards out, and gave Kawerau the lead they maintained till the end.

Footnote: Taupo should learn to play the ball, not the man. They have had three penalties awarded against them in their last two matches. They could beat any Bay team and need not play other than good football.

T. WYLIE,
FIBROUS PLASTERER,
TAMATEA AVENUE.

For Messages: Phone 212

FIBROLITE

KEEPS HOME BUILDING COSTS DOWN ...

you build for less
you save on maintenance



Your architect will tell you ...

A "Fibrolite" home is a home you will be proud of. "Fibrolite" is so adaptable to modern design ... always looks so clean and attractive.

Build in "Fibrolite" and you build MORE FOR LESS. What is more, you keep on saving! "Fibrolite" is durable and permanent ... requires virtually no upkeep. And, because "Fibrolite" is fire retardant, insurance premiums on your home cost you less.

Send now for the FREE BOOKLET illustrating how

loose, and on many occasions combined with the backs to keep the game open.

Whenever the opportunities were there, the backs tossed the ball about, to the spectators' delight.

The Taupo team was: M. Nepia, W. Purcell, R. Grace, L. Erickson, T. Rameka, J. Malcolm, B. Simon, R. Hako, J. Habib, P. Haurini, P. Hay, N. Wall, A. Grey, D. Woodward, C. Breeds. Reserve: R. Fisher.

RAPID SCORING

Taupo began quickly with N. Wall breaking away with the ball and barging his way over. Rangitaiki came back to score and convert. Taupo immediately replied when Breeds and Woodward made a foray with the ball at toe for Woodward to score. Malcolm converted.

The Rangitaiki centre cut through and scored, and this too was converted. A penalty was taken by Rangitaiki's No. 5 to raise the flags and place the local team further in the lead.

Taupo missed with a penalty, but Hay had followed up fast and he scored for Malcolm to convert and even the score at 13-all. J. Habib came to light when he forced his way over for a try.

Rangitaiki's wing scored with two minutes to go, and this was again converted to make the score at half-time: Rangitaiki 18, Taupo 16.

TAUPO CALLS TUNE

The local forwards swamped Taupo at the beginning of the second spell. Within six minutes the first five-eighths had dropped a goal, and in a further six-minute interval he converted a penalty.

Taupo then called the tune and doubled their score. Malcolm placed a penalty on to the inside of the upright, and it went over. The forwards were on top and from one of their forays Breeds went over.

He made another break-through, then passed to Malcolm for the latter to score and convert. With five minutes to go Habib went over from a five-yard scrum and Malcolm again converted. This was the final score in a very exciting match.

Soccer Competition

Results of soccer matches played at Taupo last Sunday in the South Waikato Cup competition: Putaruru 2, Wairakei A 1, Wairakei B 8 Maugakino 2.

Printed by East Waikato Publishers Limited at the Putaruru office of the company, 58 Kensington Street, Putaruru, and Published by Taupo Times Limited at its Registered Office, Heuheu Street, Taupo.

THURSDAY, AUGUST 1, 1957

TABLE TENNIS GAMES

When 27 members of the St Andrew's Table Tennis Club visited the Reporoa Club recently, Taupo won by 31 matches to 24. The matches were played under excellent conditions; a fine hall and good lighting.

The following players represented Taupo: Men, S. Mathers, H. Matthews, N. Jones, A. Madden, J. Lissington, J. Thompson, A. Cavaye, P. Bergman, D. Loughlan, G. Thimbleby, K. Meredith, A. Reading, R. Reading, R. Blackwood. Women, G. Cavaye, N. Mathers, J. Stanley, S. Johnstone, S. Rewa, F. Balmforth, O. Cavaye, F. Winterbottom, R. Booth, D. Dunn and L. Judd.

The results of play were as follows: Men's singles, Reporoa 8, Taupo 7; women's singles, Taupo 8, Reporoa 5; men's doubles, Taupo 4, Reporoa 4; women's doubles, Taupo 4, Reporoa 2; combined doubles, Taupo 8, Reporoa 5.

At the conclusion of the series the Reporoa captain, Mr D. Hope, thanked the Taupo representatives and congratulated them on their success.

On behalf of the Taupo Club, Mr A. Cavaye thanked Reporoa for their hospitality, and commented on the generally high standard of play. He extended an invitation for a return match at Taupo later in the season.

PRIMARY SCHOOL SPORTS DAY

Teams at the primary school sports held on July 25 came from Waitahanui, Oruanui, Maroa and Atiamuri. There were five from Taupo.

Basketball: Though time did not permit completion of the draw, every team was given a game, Taupo A being the only one to win the two games it played. Many players proved themselves, in particular Colleen Martin (Atiamuri), Mary Wikiriwhi (Waitahanui), Susan Habib (Oruanui), Dinah Lewis, Noleen Crowther and Ngahuia Williams, of Taupo.

From these teams will be picked trialists for a Taupo primary schools representative team.

Rugby: Games were played in senior and junior sections. The concluding game was played as visiting schools v Taupo. Due to some good running by M. Chase, M. Samuels, J. Rakatau and B. Thomson, Taupo put up a big score in the first half, but in the second the combined team began to use its weight in the scrum.

The best players on this side seemed to be L. Karaitiana, L. Hay, B. Simon, M. Simon, and B. Seymour, the small full-back.

When I say we will have a moon rocket in less than five years, it is a conservative estimate. — Brig-Gen. Hollingsworth Gregory, United States Air Force.

9, Primary C 2. Tokaanu Primary defaulted to High School C.

Representative Teams

Draw: There will not be any club games on Saturday as two representative teams, Taupo A and Taupo B are travelling to Taumarunui. At Taumarunui the Central King Country representative team will challenge Taupo A for the Fenton Cup, which is contested each year between the two associations.

Taupo B will play a friendly match against Central King Country B.

Representative teams to play at Taumarunui: Taupo A: Forwards, E. Braddock (Taupo), A. Morehu (Tongariro B), N. Jones (Tongariro A). Centres, L. Walker (Tongariro B), P. Livesey (High School A), K. Reid (Taupo, captain). Defence, C. Pitiroi (High School A), P. Kohika (High School A), S. McLaughlin (High School A).

Taupo B: Forwards, A. McNichollas (Metro, captain), P. Balmforth (Metro), H. Rewa (High School A). Centres, D. Balmforth (Metro), H. Smallman (Spa), E. Rewa (High School A). Defence, P. Kohika (Spa), T. McLaughlin (High School B), F. Dent (Taupo).

Emergencies: Forward, F. Balmforth (High School A). Centre, D. Broughton (Spa). Defence, E. Horne (Taupo).

INDOOR BOWLERS TO PLAY FIRST MATCH FOR HARDING SHIELD

Next Sunday Taupo will play Upper Atiamuri at Taupo in the first challenge match for the Harding Shield for indoor bowling clubs. There will be three visiting teams, and some keen games are expected by local players.

The following will represent the Taupo club: Mrs Walpole, Mrs Delaney, E. Graf and A. Tierney (skip); Mrs Humphries, Mrs Harding, G. Rameka and R. McIsaac (skip); Mrs Christensen, Mrs Wright, F. Stebbing and W. Tito (skip).

There will be three games of seven heads, with total points scored to count. Members have been asked to contribute toward the afternoon tea.

Last Monday's club prizes went to W. Tito and Mrs Prosser, both of whom scored 31 points.

FUTURE REFEREES

At an examination supervised by Mrs G. W. Foote yesterday, 12 candidates sat a basketball referees' examination held at the Taupo District High School.

donated by the P. W. Holdsworth. Appropriately by Noel William card of 36 point handicap reduction. Noel is an ex-Post Office staff, referred to Murupatains his member and plays regular. His card was a all players had to and very cold wi. Last Thursday played a stableft by Mrs Neale with Other scores v Mrs Watson 28, 1 Bennett 27, Mrs C

the
refr

The m
—exce
the 'd
butter
make
the ea
for thi
of fro
provid



RDS LTD.
 Store
 VER PRICES
 Phone 515

PRODUCTS LTD.
 precast concrete products prices:
 from £14/10/-
 s and paths, 24in. x 20in. at 7/- each
 netting 12/6 each
 non-rust reinforcement, £44 per 100 ex our yard

PRODUCTS LTD.
 near Spa Hotel).
 (Terry Kent) night.

SALES
 pay cash for good, sound required. We will also sell certain figure. So if you have Sales will sell it.
 might interest you—
 utton model £600 Deposit.
 es £260 Deposit
 iles £315 Deposit
 er £245 Deposit
 £275 Deposit
 £130 Deposit
 £260 Deposit
 £125 Deposit
 £125 Deposit
 m.
 will interest you.
 iday nights.
 After hours 399S

E — RELIABLE
 ove — to regulate
E RADIATORS
 2/6
 700 watts — yet only costs r to run.
 Heater now at
S LTD.
 HEUHEU ST.
 : P. STAINES.
 2. Residence, 511.

At the ninth he nearly holed a putt for an eagle three to become one-up. Jones squared the match at the 12th — a 440-yard par four — with a birdie three, and took the next with another birdie to become one-up.

The next two holes were halved in par figures, and Glading again squared the match with a birdie three at the 16th. On the 540-yard 17th Glading hit a tree, but finished on the fairway. Jones hit a long tee shot and put his second wood six feet from the pin.

WOON'S PUTTS OFF

Glading was on for three and sank his putt for a birdie four. Jones's putt for an eagle three sat on the edge of the hole. The last hole was halved

TAUPO SOCCER CLUB HAS TO WITHDRAW FROM B.O.P. CONTESTS

Because so many of the Taupo United Association Football Club's players are required to work on Saturdays, the committee has decided to withdraw from all Bay of Plenty competitions for the remainder of the season.

Mr J. L. Burge, the club secretary, says the Taupo club and some Rotorua clubs had to default in a number of recent games, and the committee thought the game would suffer in consequence. Other clubs had expressed similar views, but most were in a position to field teams on Sundays.

The club president, Mr F. Hoyes, had interviewed several representatives of other clubs, and as a result a regular programme of friendly Sunday games was arranged with Mangakino, Kinleith, and others.

Mr Burge said there was every reason to expect that an association of clubs in the district would be organised soon, and it would be possible to arrange for competition games.

At a recent meeting Mr Howes said that support for the local club was satisfactory, but local working hours left no option but to switch from Saturday to Sunday football, if the game were to be kept alive.

All committee members agreed with that, Mr Burge said, and the Bay of Plenty association had been notified.

Soccer Results

Results of soccer matches played at Taupo last Sunday in the South Waikato Cup competition: Taupo A 2, Maraetai nil. Wairakei B won by default from Kinleith.

Printed by East Waikato Publishers Limited at the Putaruru office of the company, 58 Kensington Street, Putaruru, and Published by Taupo Times Limited at its Registered Office, Heuheu Street, Taupo.
 THURSDAY, AUGUST 15, 1957

Lée Martin (Waikato) and Mr V. Hollis (Waikato) returned thanks on behalf of the teams and the associations. All expressed the hope that future committees of the Taupo club would be willing to allow the fixture to be played at Taupo.

Results of matches were as follows (Waikato names first): Saturday afternoon: Glading and Jones all square, Woon beat Gordon 4 and 2, K. McFarlane beat F. H. Parker 2 and 1, M. R. Thompson beat J. A. Ramsay 4 and 2, D. G. Bullick lost to C J. Grant 1 up, M. Leech beat R. F. Mackie 5 and 4, J. G. Ferguson lost to P. L. Peacock 3 and 2, K. N. Davies beat L. D. Drummond 5 and 4, K. G. Bartlett lost to R. I. Harrison 2-up, I. McInnes lost to H. A. Henderson 4 and 3, S. Bryant beat M. J. Thornton 2 and 1, L. Hodgson lost to A. Fannin 6 and 5.

Sunday morning: Woon lost to Jones 4 and 2, Glading beat Gordon 2-up, Thompson beat Parker 2-up, McFarlane lost to Ramsay 1-up, Leech beat Grant 4 and 3, Bullick lost to Mackie 4 and 3, Davies lost to Peacock 2 and 1, Ferguson lost to Drummond 4 and 3, McInnes beat Harrison 5 and 4, Bartlett beat Henderson 1-up, Hodgson lost to Thornton 1-up, Bryant lost to Fannin 2 and 1.

WOMEN'S GOLF

The following qualified last week for the Ladies' Golf Club championship: Mrs Foote 78, Mrs Bennett 87, Miss Branson 87, Mrs Thomas 88, Mrs Young 89, Mrs Neale 93, Mrs D. Logan 97, Mrs Colbeck 97.

Junior championship: Mrs Neale 93, Mrs D. Logan 97, Mrs Colbeck 97, Mrs O'Neill 98, Mrs Watson 101, Mrs Nelson 102, Mrs Leech 102, Mrs Colson 102.

- DIAPHRAGM CARBURETION
- LIGHT WEIGHT
- LESS REPAIRS
- NO SWIVELLING

KAI
 PAORAHAPE STR

Mat
 Stocks of All Building Board, Pinex Hard Roofing, I

FIBROLITE MOULD

- CHIMNEYS—Open F
- SURROUNDS—Tile, F
- BOILERS—12 to 20
- WASH TUBS—Single
- FOUNDATION PILE
- AIR VENTS.
- BUILDING BLOCKS**
- E.W. PIPES & FITT
- CONCRETE PIPES—
- BRICKS—Fancy Surr
- TILES—Flooring Red
- Wall.
- GATES—Hurricane V
- FLUSH DOORS—Cor

PAL
 Pr
ANVIL P
 Compl
W.
 RU.
 Phones:

VAUXHALL

BEDFORD

**S
A
L
E
S**

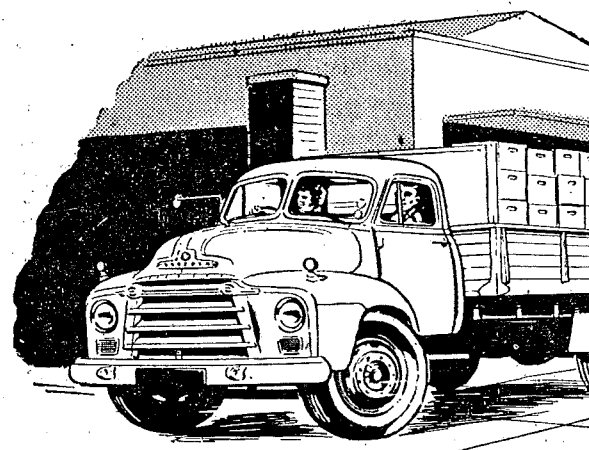

LUBRICATION — PETROL —

R. M. (TAUP

Phone 557. After Hours 546K. **TONGARIRO**

ply the pressure could have downed their score.

The game itself was scrappy. Being a friendly one with nothing at stake, this affected the attitude of the local players.

Taupo seniors surprised by defeating C.O.B. in a game that at times reached great heights, and then at others was so scrappy that it was a disgrace to see. Again a game with nothing at stake, and a case of two teams filling up the many gaps with "odd" reserves. So much so that the last two players to turn out for Taupo did so without boots.

The game fluctuated from end to end

break through and score near the line. Tito missed.

Missed A Sitter

C.O.B. forced Taupo back to their line, but a good kick which was followed up set the black-and-white backs away, but a knock-on 15 yards short ruined the movement.

Fisher then tried to break through when he kicked and followed up to catch the fullback, and so send the ball loose.

Woodward and Tito were close enough for Tito to kick through, but Woodward beat him to gather it in and scored under the posts. Tito missed the siter.

Near the halfway the ball came loose and Thimbleby, in bare feet, gathered it in and braved the boots to make a fine dash right through C.O.B. to score. No kick was attempted.

The game ended with Taupo winning by 14 points to 3.

Mr F. Harding was the referee.

Never Had Toothbrush

The matter of toothbrushes is important, and often attached to the child's appointment card is a note asking to bring his toothbrush to his next appointment, so that the correct way to brush teeth may be shown.

"We have found from experience that 80 per cent. of the children bring along a new brush," said the nurse.

"We felt that this shows that many of the children have never had a toothbrush of their own before, or that their old one was not in the best of condition."

The age at which a child stops attending the clinic depends on the numbers attending, but free dental treatment is still available until the age of 16.

Quick
MODE
CAR WASH
We also
ROBANDS
Phone 445S.

Y E

T RADIO BUY

... Waited for it ...
- For so little

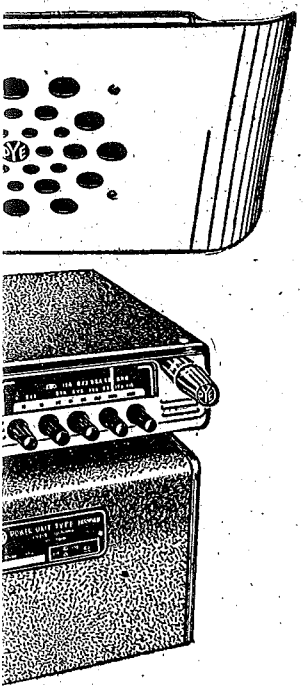

308/9 8-valve push-button
35/19/6

MODELS AVAILABLE

7 bandsread car radio. Brings you radio entertainment. £32/19/6.

easy to instal. Its amazing performance in any car, big or small. £24/19/6

AVAILABLE FOR 6 OR 12 VOLT.

Buy Now at
(Taupo) LTD.
Local Appliance Centre
Tongariro Street

P
Y
E

INDOOR BOWLS

Highest scores at the Taupo Indoor Bowling Club's tournament on Monday night were: Men: G. Rameka 32, F. Stebbing 30, P. Rackley 29, F. Mahanga 27. Women: Miss G. McIsaac 36, Mrs Burns 33, Miss B. Flutey 32, Mrs F. Bostock 26.

TAUPO UNITED SOCCER TEAM TAKES FENTON CUP IN KEEN MATCH

Taupo United were beaten by three goals to two by Wairakei I.C. in the Fenton Cup final last Sunday. The match was played in adverse weather conditions, but despite that keen football was seen.

Taupo opened the scoring with a good shot from J. Rademakers, but Wairakei drew level shortly after. Taupo found the net once again before half-time with a goal by R. Alkema. At that stage Taupo had the upper hand, but could not add to the score.

The second half found Wairakei on the attack, and they were rewarded with a goal from E. McGurn. Both teams then went all out for the winning goal, and after several near-misses by both sides, Wairakei scored just before the final whistle.

The Taupo club president, Mr F. Howes, presented the cup on Mr Fentons' behalf, and offered congratulations to both teams at the conclusion of a fine series of games.

Printed by East Waikato Publishers Limited at the Putaruru office of the company, 58 Kensington Street, Putaruru, and Published by Taupo Times Limited at its Registered Office, Heuheu Street, Taupo.

THURSDAY, AUGUST 29, 1957

the *fin*
electric range mo

It thinks for itself with the easy-to-use "Cook-Master". When you're busy or away, it turns the oven on . . . cooks your food . . . then turns off automatically at the time you select. Dial-a-meal yourself . . . soon. The new Frigidaire Imperial electric range is as handsome as it is handy . . . the finest electric range money can buy. It looks as modern as tomorrow!

FAST, EASY-CLEAN ELEMENTS
rise right up at a touch, makes cleaning so quick, so simple. And those Radiantube elements heat up ready for cooking in next to no time at exactly the temperature you want.

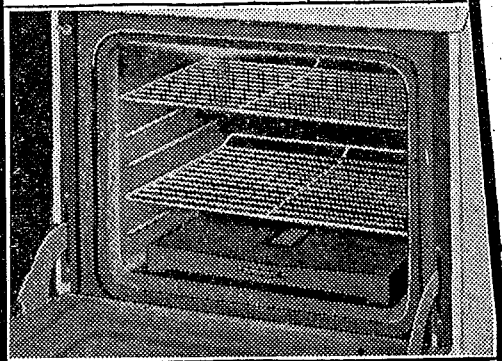
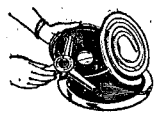

BIG, BIG OVEN with the new Visi-Door—you'll cook with ease and economy for even the biggest family or gathering of guests. Interior light with manual and automatic control dispels gloom-oven guesswork.



FRIGIDAIRE

IMPERIAL ELECTRIC
Distributed by Frigidaire Division of General Motors
Frigidaire Electric Ranges may be purchased from Dealers and most Electric Power Boards.

G.9665

1957 SEASON

BOP ROTORUA DIV 1957
Taupo United - withdrew

Coach: Ron Girling & Phil Henry	20-Apr-57	a	Rotorua Crusaders	2 - 0	Fred Howes 2	friendly
Team members:	27-Apr-57	h	Rotorua Rangers	1 - 3	Graham Parker	friendly
Alkema, R.	28-Apr-57	h	Wairakei International Contractors	5 - 12		
Farrell, E.	04-May-57	a	Rotorua Crusaders	2 - 3	J. Walpole, Trevor Drummond	Chatham Cup
Henry, Phil	11-May-57	h	Rotorua Caledonians	4 - 2	Phil Henry 3, J. Smith	Chatham Cup (BOP Rotorua area Final)
Howes, Fred	18-May-57	h	Rotorua Rangers	3 - 2	Shepherd, E. Farrell, ?	South Waikato Cup
Matthews, Bill	01-Jun-57	rot	Kawerau Town	5 - 6	E. Farrell 3, Graham Parker, R. Alkema	Fenton Cup Final
Parker, Graham	04-Aug-57	h	Maratai	2 - 0		
Shepherd	25-Aug-57	h	Wairakei International Contractors	2 - 3	Dutchy Rademakers, R. Alkema	
Smith, J.						
Stagg, H. (gk)						
Walpole, J.						

H. Stagg, Ron Girling & Bill Matthews selected for Rotorua Association team to play Gisborne
 R. Alkema & Phil Henry selected for BOP

second team formed - Wairakei - played in Sunday competition						
Wairakei "A"	28-Jul-57	a	Putaruru	1 - 2		South Waikato Cup
Wairakei "B"	28-Jul-57	h	Mangakino	3 - 2		South Waikato Cup
Wairakei "B"	04-Aug-57	h	Kinleith	wbd		South Waikato Cup

TAUPO ASSOCIATION FOOTBALL CLUB – 1956 OR 1957 SENIOR SQUAD

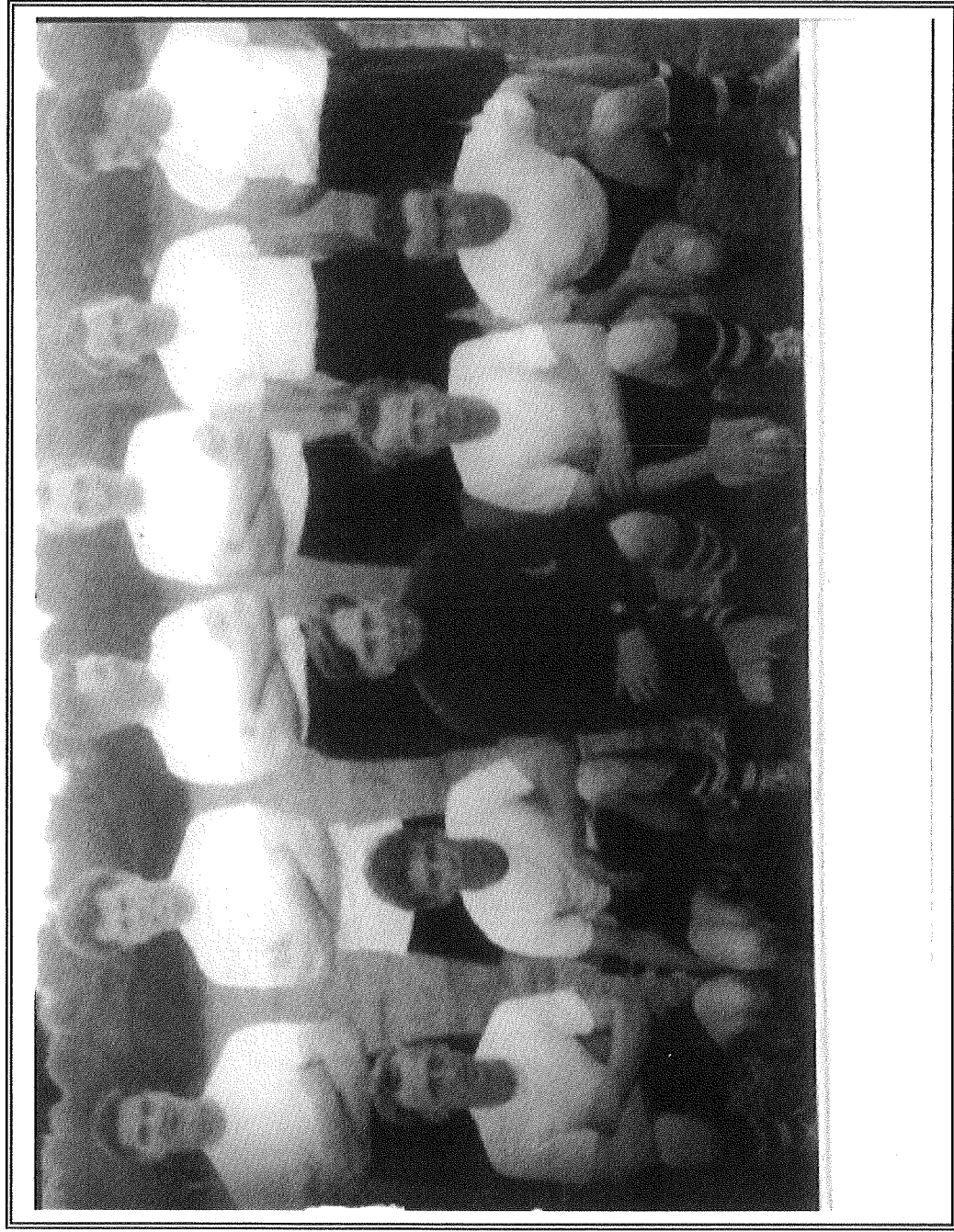

Back row(L-R): Anon Don Jones Harry Chapman Graham Parker Dick Arrowsmith Phil Henry
Front row(L-R): Fred Williams Anon Anon Alf Anderson Frank McMahon

TAUPO ASSOCIATION FOOTBALL CLUB - 1957/1958 SENIOR SQUAD

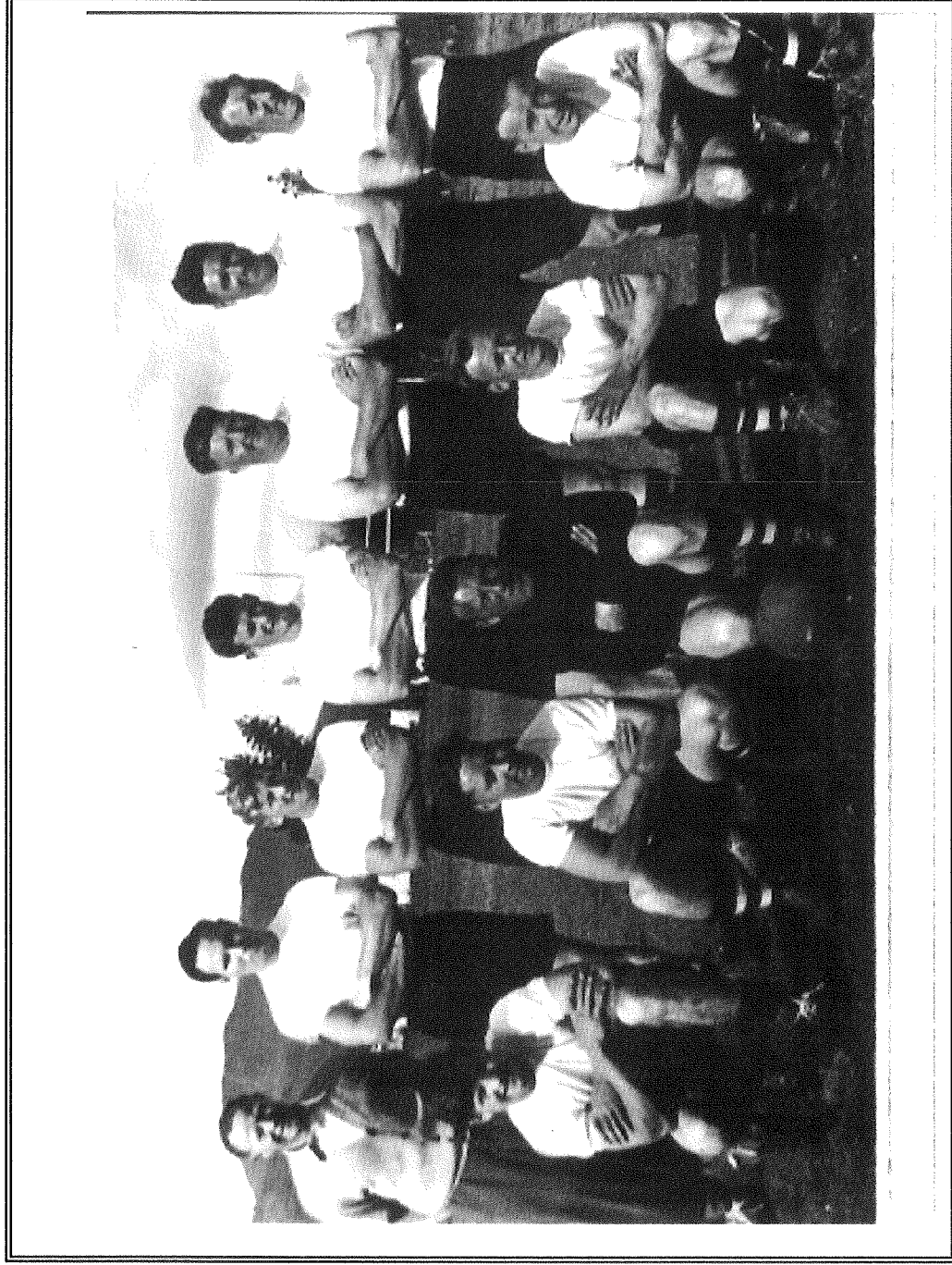

Back row(L-R): Sandy Moir Graham Parker Anon Phil Henry Henry Chapman Anon Anon
Front row(L-R): Anon John "Dutchy" Rademakers Dick Arrowsmith Fred Williams Frank McMahon

Taupo United A.F.C.

A meeting was convened to form the above club, by Jack Burge, Peter Fry and Fred Howes. The meeting was held at the residence of Jack Burge in Root Hill.

As we wanted to commence in the 1956 season, a meeting was called for the election of officers etc.

The meeting was held in Leadbetter's Transport office at Robert Street.

Not a particular good turn out, but sufficient numbers to get a team off the ground.

The committee was duly elected. Jack Burge being our first secretary, Fred Howes was President, Trainer and selector.

I think the rest of the meetings were elected to the committee.

We approached the Bay of Plenty association for membership, this was granted together with a lot of encouragement and advice.

The wife of the Rotorua Rangers Manager kindly acted as our delegate to the S.M.C.

We approached the Taupo primary school for permission to use the school ground. As the Taupo Rugby Club had just vacated it. Unfortunately they had left it in an unplayable condition.

So we had to promise to bring it back to a grassed area before we were given permission.

With the help of equipment loaned by Cory Roaka we got stuck in and resowed the whole area.

Our next need was goal posts, once again in usual Taupo fashion, we finished up having these donated by the Woodwood Mill.

We purchased material in bulk and the wives made up the football shirts and corner flags. Our first team colours were green and white. Glasgow Celtic's colours.

I regret I do not have the results of our early games, but our first season was a struggle, although we went from strength to strength as the season progressed. Several lads from Wairakei joined the club which gave us a balanced team.

No club man was ever dropped though, but we did have a few drop out because of the travel problem, so we were on the lookout for new blood all the time in the early days. Some of our younger players could not stand the pace because the football played was senior grade.

Our second season was a different story, with the introduction of the International Contractors at Wairakei, who were building the power house. We found we had enough players to form a second team which we called Wairakei. This team was entered into the Sunday competition. As Charlie Hatt did not like his boys having Saturday off. A few of the stalwarts always took time off to play for us. The result being we reached the Bay of Plenty finals of the Chatham Cup.

Having the second team made training easier, as Taupo Utd. would play Wairakei at every possible chance. In fact we played for the Fenton Cup which was donated for these occasions.

Getting back to our first year, a few of the characters involved, Unfortunately this is only by memory, so apologies to any of my old friends I fail to mention.

Vice Presidents, Messrs Father De Bree, Jim Barney, Joe Storey -- Bob Ying

Players. Arthur Yin Trevor Drummond Joe Braddock, Dutchy Rademakers Bill Matthews, Phil Henry, Ron Girling (Captain) U Alkema R. Arrowsmith, Ron Harding, Jim Storey, John Stebbing, Fred Williams, Ken Wood, Scouse Smith, Jock Lyshat, Jimmy Braddock (Rugby permitting) Peter Fry

Referees Mr. Kennedy Mr. Bill Harding

Highlights of our first couple of seasons.

Our first home game the numerous supporters who turned up.

Our first victory at Rotorua, It took three hours to get past waiotapu hotel.

The St. Johns Benefit match we played against Taupo Rugby Club, the first half we played soccer the second half rugby. We won both games, please do not remind Owen Delaney. We even beat them at darts in their old club rooms behind Cafe Monarco, then Reids Milk Bar.

Our end of season friendly match against Napier, not too friendly we won.

Of course our final against Kawerau in the Chatham Cup, the winner had to play Gisborne City, Our finances were so strained we would have had to hitch hike there.

Numerous memories, my reporting for the Taupo Times

Escaping from the irate supporters after knocking out the same player twice in the match. He was a Czechoslovakian ex pro. The idol of Rotorua Rangers, he was at centre forward and I was filling in at goal keeper, when we collided in the first half. They carried him off and he returned at half time to play as Goal keeper. Alkema who was our goal-keeper regular goal keeper was playing at centre forward when he got injured, so we swapped places. Unfortunately while I was playing at centre forward I collided with the goal keeper, who was carried off once again.

Alkema incidently was a Dutch pro club player, which reminds me of the day I was playing as goal keeper to make the number up, when I was approached by the selector to play for B.O.P.

After I controlled my laughter I told him to have a look at our goalie, who ~~the~~ made the B.O.P team together with Phil Henry.

Kevin Mc Kerkindale
Graham Parker

MEMORIES OF 1956/7

BY FRED HOWES

[WRITTEN FOR 1984
CLUBROOMS OPENING]

1958

TAUPO UNITED IN RECESS

1959

**NO TAUPO CLUB BUT WAIRAKEI TEAM IS
FORMED**

that lie around the shores of this magnificent lake.

A.C. BATHS TO BE DEVELOPED

A progressive plan to develop the A.C. baths area with another bathing pool and smaller pools and motor camp is being discussed by Taupo Borough Council.

The baths are under review at present and the reconstruction will include the erection of a new manager's house and a regrading of the entrance so that it is not so steep.

According to Cr C. Currie the baths may have a much higher medical value than has been realised and he considers it likely that they would be well patronised were there a motor camp nearby so that people could use the baths regularly.

Information Wanted

A correspondent has written asking for details of a crimson dwarf variety of gum, called, he thinks, the Cambelai — or possibly the Campbell Gum. He has heard the native tui is particularly fond of this species and says it is difficult to obtain accurate information. He wishes to know particularly whether it is a high, medium or low-growing type, whether it is a wide or long, thin leaf, and where young trees may be obtained. Details could be forwarded to this newspaper.

angler and some of the fish taken locally lose nothing in size when described in the cosy hotel lounge in the evening after the day on the lake or river.

For the more robust hunter, there are deer and pigs in the hills not far away. There are lovely walks within a few minutes of the township, each offering a magnificent panorama of the lake and its shores.

It is undeniable that the lake and its shores and beaches are destined to be the playground of New Zealand.

Logging Trucks May Back-load In Future

An experiment is under way to consider the possibility of building logging trucks which could carry a back-load of merchandise to the area they carted timber from.

This could be of particular interest to Taupo where timber trucks carting the raw material out of the district must return empty because of the open jinker they use.

If the present experiment is a success, it would mean a truck could cart timber to, say, Napier and return with a big load of goods for the town. Although those involved in the experiment say the actual tare weight of the truck would be heavier than the present trailer units, the saving in dead running could well reduce transport charges generally.

usually with the tourist trade.

"But what have you here in the way of times?" he asked, to be the leading for the whole Island within although there is to be done, you have work with."

Mr Bretherton particularly impressed attitude of the towards the pro town. It was good enthusiastic about go ahead.

HOCKEY AND TO HAVE PLAYING

Until a more permanent can be found for and hockey organised be encouraged to grounds in Kaiman

Taupo borough have suggested that is not a great deal between the size of the fields, soccer on the hockey field temporary measure. It that the hockey inside the soccer manawa reserve enough space for a men's hockey ground.

HOCKEY GETS UNDER WAY

A well attended Taupo Hockey Association decided on Tuesday night the sport locally, elected a provisional as follows: Chairman Daniel; secretary, Kiddle; committee, son, N. McMahon Arrangements were construct new association will on the soccer grounds. Play will 6 and intending telephone 629D or

M. Wilson 2; vegetable S. Rowan 1, Miss M. 2.

TRIMU C.W.I.

meeting of the Te C.W.I. was held at the of Mrs S. Peihopa, Mill, Te Rangitira. hour competition and was won by Mrs R.

itions were judged by F. Harris and R. results as follows:

A. Wall 1, K. O'Keefe 3, J. Rameka 4; O'Keefe 1, A. Wall 2, 3, W. Te Amo 4; A. Wall 1, K. O'Keefe 3, S. Peihopa 4. were presented to the birthday spray to O'Keefe.

another position. One Taupo's most popular and peeted ministers, the Tangohau has been here 1954 when he was appointed. He was made vic the new diocesan district Taupo early last year. successor will be the Rev J. W. Rosvear, who comes Taupo from Te Aute Co

Tokaanu Progress

Tokaanu has largely recovered from the blow it received it was threatened with flood and the township is showing signs of renewed confidence progress. The latest additions the amenities provided modern and attractive building shop recently completed by J. McBride. Mr McBride believes that Tokaanu will become the most attractive place South Taupo.

MOTORISTS!

Cold mornings won't worry you, if — you invest in a —

LUCAS BATTERY

FROM

KARLECTRIC LTD.

ahape Street

Phone 51

THERE IS NO SUBSTITUTE

IF IT'S MADE OF

Specialists in:

DOORS (all kinds)

SASHES

FRAMES

WINDOWS

RUN TIMBER, etc

LET T. & R. TACKLE

SALVAGE & REPAIR LTD.

Cash Buyers

BOTTLES

SACKS

METAL

We Call and

Ring 418

26/30 Runanga Street, Taupo

Taupo Times 28/5/59

SUGGESTIONS

..... 37/6	Aluminium CASSEROLES, round 31/6
..... 52/6	ENGLISH TEASETS £5/12/6
Surprising Egg, etc. 37/6	OTHER TEASETS £2/19/6
Four	Utility DINNER SETS from £4/19/6
..... 25/-	ENGLISH CUP, SAUCER AND PLATE from 9/6 to 42/6

AT

E LTD.

Tiz

Downer.

3 HURCH
Madill.
School and

the Lord's

e. Offering
Refugee

RCH
oad)
MacLeod
Litt.
School and

orship and

vice at St.
Church.
me.

TERIAN

et
ool.
ice.
n., Sunday

ewis.

IBLY
L.
et
ool.
Service.
vice to be
n Church.
nior Girls'
5-10 years
Handwork,

very Boy's
Handwork

Sale

good order,
O.F. \$90.
Timu St.

d, A1 con-
\$750. Ring

RS

are vehicle

-TON
y)
conditioned
ntial, good
d tray with
near \$120,
change car.
353 Taupo,
ings).

— DODGE

gas stove,
ve berths,
esses, etc.
good tyres,
Suitable for
accommoda-
contractor
Deposit of
alance over
pected by

ME LTD.

ING

EARING

r grassing.

né 482D.

PAINTS

ous

- 1953 HILLMAN Station Wagon.
- 1952 CHEVROLET. Two - tone, coral and grey, in good order and priced to sell.
- 1951 SUPER SNIPE. Immaculate. Original Black finish. A quality car.
- 1951 MORRIS Minor Convertible with new hood.
- 1950 OLDSMOBILE Futuramic, automatic drive, V8 Rocket motor.
- 1948 FORD V8 De Luxe, new paint and upholstery.
- 1947 AUSTIN 8.
- 1947 FORD V8 Sedan, as new.
- 1946 FORD V8 15cwt. A very tidy truck with canopy.
- 1940 PONTIAC. Spotless interior, new paint.
- 1939 PACKARD Convertible, 6-seater. Spare motor. A very smart car.
- 1939 FORD V8 Coupe.
- 1939 FORD V8 15cwt.
- 1939 CHEVROLET, completely reconditioned and painted.
- 1938 CHRYSLER with 1952 motor. Re-upholstered and painted.
- 1938 VAUXHALL 14.
- 1938 CHEVROLET.
- 1938 PLYMOUTH Sedan, cheap, reliable car.
- 1938 WILLYS. Motor overhauled. Economical and roomy.
- 1938 MORRIS 12.
- 1938 STANDARD 12.
- 1938 DODGE, good order.
- 1937 CHEVROLET. Repainted and new upholstery.
- 1937 FORD V8 Convertible, a very smart car with new motor.
- 1936 FORD V8. Good order.
- 1936 CHEVROLET. Popular cheap car.
- 1936 PLYMOUTH. Reliable, sturdy car in fair order.
- 1936 VAUXHALL 14. Cheap car in good order.
- 1936 AUSTIN 7.
- 1932 DODGE Coupe.
- 1934 OLDSMOBILE. Runs well, sealed beam headlights.
- 5 h.p. Johnson OUTBOARD MOTOR, 15 hours use.
- LARGE Caravan, complete with air brakes, awning, etc. Ready for any trip. This Caravan can be purchased with or without four-wheel drive jeep.
- Two Trailers.
- SMALL Folding Caravan. Cheap.
- NEW 15ft Twin Cockpit Ply-

The results, Taupo 6, Kowhai 12; Taupo 10, Linfield 7.

Both matches were played in a friendly and competitive spirit and Taupo actually showed more speed, confidence and knowledge of the game than their opponents. Results of Rugby games were: Kowhai School 3, Taupo 0; Cornwall Club 15, Taupo 0.

Taupo Times 4/6/59
Soccer Tourny
Won By A
Wairakei Team

A six-a-side soccer tournament staged at Kurau Reserve, Rotorua, on Queen's Birthday resulted in a win for Wairakei. Entered in the tournament were teams from Rotorua (Rangers, Crusaders), Kawerau, Whakatane and Wairakei. After some interesting soccer between the various sides, the final was contested between Wairakei and Crusaders. The result was a win for Wairakei by 13 points to seven.

In the first half of this final game, following a nice piece of teamwork by Wairakei, Gallagher crossed and Dewar headed a lovely goal. Henry and Cowie combined well to notch Wairakei's second goal when Henry, taking a pass from Cowie, scored from close in. Crusaders, not to be outdone, scored a well-deserved goal when their centre headed through. Henry added another goal and Crusaders attacking strongly were unlucky not to score again when, with the goalkeeper beaten, Dewar headed the ball out from under the bar. Goalkeeper Arrowsmith was well tested in the second half when Crusaders redoubled their efforts trying to make up the leeway. Griffiths nearly increased Wairakei's lead when he came near to scoring with two lovely headers. The game concluded without further score.

The team: R. Arrowsmith, W. Cowie, P. Henry, G. Griffiths, S. Gallagher and A. Dewar.

DINE at "Cindy Lou." Under New Management.

MOTOR TRIMMING
Upholstery
Tailored Seat Covers
All types of Canvas Work.
FURNITURE Recovered and Repaired.
D. H. JAMIESON
Horomatangi Street
(next to old Tennis Courts)

LEARN TO DRIVE
SAFELY, CONFIDENTLY,
PROFICIENTLY, ALERTLY
TAUPO DRIVING SCHOOL
Phone 306M. Aubrey Dyke.
14 Elizabeth Street.
Transport Dept.
Certified Instructor.

difference here was S. Nightingale who marshalled her team in a first-class fashion. Jets made several slick passing movements and the score is no real indication of the ability of the teams. All Stars 23, Silhouettes 18. L. Rena played a nice game for Silhouettes and B. Branley and Daly were reliable players for All Stars.

The draw for Friday is as follows:

- 7.15 p.m., Bears v Taupo Trotters (F. Scarf, B. Wishart);
- 7.45 p.m., Stoppers v Wairakei (Alex, J. Ireland);
- 8.15 p.m., Comets v County (H. Otene, J. Dean);
- 8.45 p.m., Fire Brigade v Yachties (F. Scarfe, Alex);
- 9.15 p.m., All Stars v Jets (W. Williams, L. Vernon);
- 9.45 p.m., Bears v Saints (D. Harris, H. Otene).

Bye: Silhouettes (women).
Duty teams: Bears and Jets.

Taupo Basketball

Basketball draw for Saturday is as follows:

- 1 p.m., court 1, Taupo Pr. B v Taupo Pr. D (S. Orr);
- court 2, Taupo Pr. C v Tauhara B (A. McNicholas).
- 1.30 p.m., court 1, Kiwi v Metro (J. Harris).

A pilot scheme for "beef" production is to be in the United Kingdom. Harper Adams agricultural college at Newport, Shropshire, is to conduct the "beef" scheme for automatic or automatic feeding of cattle. Mr. R. G. Mortimer, in charge of the scheme at the college, said that only farmers would be able to take the outlay. He had in mind some of the big farms in England.

The capital required would be from £5000 to £10,000. The demand would be for low quality beef. The need would be for a beast of 900 to 1000 pounds which could be slaughtered at 18 or 20 months old.

A start will be made with 20 or 40 cattle, Herefords and crosses. An important part of their diet will be green silage.

One of the big advantages of the system, according to Mortimer, is that cattle "kept going" all the time thus avoid fluctuations in weight gain which occur when animals leave the yard for grazing. Eventually the feeding operation could be controlled by time switches.

Recipes For Our Readers

MOULDED TONGUE, VEAL

Ingredients: 1 knuckle veal, 4 sheep tongues, 3 hard-boiled eggs, bay leaf, few peppercorns, salt, 1 carrot, 1 dessertspoon gelatine dissolved in 1 tablespoon boiling water.

Method. Cover knuckle with water, add peppercorns, bay leaf, peeled carrot. Cook gently till veal is very tender. Remove meat, strain liquid, reduce to 1 pint, add gelatine. Cook tongues, skin, slice, put in mould with slices hard-boiled egg, chopped veal. Pour over veal stock. Allow to set.

VANILLA-NUT

Ingredients: 1lb. vanilla marshmallows; 1/2 cup milk; 1/2 cup toasted almonds, chopped; 1/2 cup cream, whipped; pinch salt; 1/2 teaspoon vanilla; squeeze lemon juice.

Method: Put chopped marshmallows, milk, over hot water. Stir occasionally till melted, cool. Fold in toasted almonds, vanilla, cream. Add salt and lemon juice to taste. Chill till thick, spoon into cases.

SALAD LOAF

Cut-and-come-again savoury meat loaf is flavoured with tomato and Worcestershire sauce.

Ingredients: 1lb. round or top-

CHOKO JAM

Ingredients: 1 dozen coconuts, 1 large pineapple (slightly ripe if possible); 2 lemons, preserved ginger; sugar.

Method: Mince peeled chokoes, pineapple, ginger, coarse cutter. Put in blender, juice, grated rind of lemons (including pith and pips in bag for a good set). Cover and blend gently till soft. Stir in 1 cup sugar for each cup liquid dissolved. Boil rapidly till thick. Bottle, seal hot.

PORK CHOPS

Ingredients: 1 1/2 lbs. pork chops, little fat for frying; 1 onion, sliced; 1 can crushed pineapple, medium carrot, sliced; 2 spoons malt vinegar; 1/2 teaspoon pepper.

Method: Fry chops in hot fat, brown both sides, add onion, cook few more minutes. Add carrot, vinegar, pineapple, liquid, pepper, salt. Cover and simmer 1 to 1 1/2 hours till tender.

CARAMEL MUFFINS

Ingredients: Two cups butter, softened, 1/2 cup firmly-packed brown sugar, 1/2 cup walnut halves, one teaspoon cinnamon, two cups plain flour, two teaspoons baking powder, 1/4 cup sugar, 1/2 cup salt, extra two ounces approximately threequarters milk.

leaders. As it was, their backs, with limited chances, looked a cut above the opposition. Players to stand out for Old Boys were: S. Morunga and B. Wall in the backs. In the forwards, T. Bidois gave a brilliant exhibition of loose play—seldom seen this season.

Revering in the broken play and being in the right place at the right time his three tries were a fitting reward for consistent backing up. Giving him good support was R. Kapua and G. Koopu, with the latter dominating the lineouts with some fine leaping. S. Hemara, the hooker, again turned in an outstanding performance by winning all but two scrums.

For United, T. Rameka (full-back) and M. Gordine impressed with limited opportunities. D. Tomoana, the halfback, although looking short of match play, gave a plucky display behind a beaten pack. In the forwards, N. Williams stood out with good cover defence. Improving with every game is the fiery, young siderow forward, K. Marks. Another of the younger brigade, M. Hurae, also impressed.

C.O.B. 21, tries by T. Bidois (3), and G. Kapua (1). Penalties by G. Koopu (3). United 5, try by N. Williams (1), conversion by A. Grey.

Referee: Mr D. Harris.

Tongariro-Taupo

In a rather scrappy game on No. 1 ground, Tongariro drew with Taupo to retain second equal place in the championship. As both teams employ the passing game as a medium for scoring points, it is hard to understand why they both persisted in tactless kicking. For most of the game it was a repetition of dropped passes and lineouts. To sum it all, the draw was a fair indication of the game.

A win to either would have been more flattering. Players to

Printed by East Waikato Publishers Limited at the Putaruru office of the company, 58 Kensington Street, Putaruru, and Published by Taupo Times Limited at its Registered Office, Heuheu Street, Taupo.
THURSDAY, JUNE 11, 1959.

port was T. Percival and T. McAneney.

Taupo 5, try by K. McAllister, conversion by L. Balmforth. Tongariro 5, try by C. Poole, conversion by R. Downes.

Referee: R. Dixon.

T.T. 11/6/59

WAIRAKEI SOCCER SIDE BEATEN AT WHAKATANE

At Whakatane on Sunday, Wairakei Soccer Club, with a rearranged team owing to injuries, were no match for a young, go-ahead Whakatane team led by that mercurial veteran, Kirk.

Kirk had a field day, scoring eight of his side's ten goals. Within 30 minutes Whakatane had scored four goals through Kirk's opportunism. Dewar, on Wairakei's right wing, had to retire after 35 minutes with a strained back. Just on half-time Good made it five for Whakatane.

The second half began with Chapman replacing Dewar in the Wairakei team. Things looked better for Wairakei when Imboden and Wade scored. Then Kirk and Good repeated their first half performance when Kirk scored four and Good one.

Kirk took full advantage of the numerous misunderstandings in the Wairakei defence. It was a bad day for Wairakei, who never gave up trying, but as a team just didn't seem to knit.

The teams:

Whakatane: Bromerde; P. Maynard, R. Massey; B. Loundes, W. King, C. Donagher; T. Jager, R. Lucas, A. Kirk, W. Kelly, B. Good.

Wairakei: A. Murphy; R. Arrowsmith, W. Matthews; W. Cowie, P. Henry, H. Mason; A. Dewar, S. Gallacher, F. Wade, G. Griffith, W. Imboden.

Referee: Mr L. Smith.

Three of the Wairakei team, P. Henry, W. Cowie and G. Griffith, were invited to play in the Bay of Plenty rep. trial game at Kawerau on Sunday.

given a far better account of themselves if there were more courts in Taupo for them to practice on. Play was most enjoyable throughout the afternoon and the home club provided an excellent afternoon tea.

Messrs D. Dawson, R. Bjorngaard and P. Staines all played very well for the Taupo club, winning all of their games. Results (Taupo names first):

Men's singles: T. Waldron beat H. Waterhouse 21-17; D. Dawson beat R. Hunter 21-3; J. Polly beat W. Bamford 21-3; R. Bjorngaard beat J. Wilson 21-7; J. McLeod beat C. Quidding 21-3; P. Staines beat D. Gill 21-5; R. Davies lost to J. Boocock 17-21; R. Fisher beat L. Bretherton 21-19.

Women's singles: M. Mitchell lost to M. Dean 5-15; D. Aldworth lost to D. Gray 6-15; M. Douglas lost to J. Hammond 4-15; L. McMillan lost to M. McLeod 2-15; L. Staines lost to M. Wilkins 14-15; C. Edwards lost to P. Wood 3-15; R. Aldworth lost to J. Ladkin 0-15; B. Middleton lost to J. Waterhouse 1-15.

Men's doubles: D. Dawson and J. Polly beat H. Waterhouse and R. Hunter 21-8; K. Waldron and Fisher beat Bamford and Wilson 21-18; Bjorngaard and Staines beat Quidding and Gill 21-7; Davies and McLeod lost to Boocock and Bretherton 16-21.

Women's doubles: Mitchell and Douglas lost to Dean and McLeod 12-21; McMillan and Staines lost to Gray and Hammond 1-21; D. Aldworth and Edwards lost to Wood and Wilkins 5-21; R. Aldworth and Middleton lost to Ladkin and Waterhouse 2-21.

Mixed doubles: Waldron and Mitchell lost to Waterhouse and Dean 18-21; Dawson and McMillan beat Hunter and Gray 21-12; Polly and Staines lost to Bamford and Hammond 17-21; McLeod and D. Aldworth lost to Wilson and McLeod 14-21; Bjorngaard and Douglas beat Quidding and Wilkins 21-12; Staines and Edwards beat Gill and Wood 21-12; Davis and R. Aldworth lost to Boocock and Ladkin 8-21; Fisher and Middleton lost to Bretherton and Waterhouse 4-21.

dicap now 12), R. Reid 37 points (handicap now 14), P. A. Kuna 35 points.

The field was smaller as the club was competing in the third of the Bay of Plenty shield matches at Te Puke.

And what a sorry story came from there. With handsome wins over Te Teko, and the strong Rotorua club, Taupo looked to

Women's Golf

The results of the all-iron match on Thursday were as follows:

Mrs Douglas 97-27, 70 net; Mrs Pearse 101-28, 73; M. Marlow 97-23, 74.

Reductions in handicap: M. Douglas 27 to 23. Mrs Svens has now earned an L.G. handicap of 34.

The following players represented Taupo at Te Puke in the pennant match on Monday:

Seniors, Mrs Bennett and M. Thomas; intermediates, M. O'Neill and Miss Heske; juniors, Mrs Barlow and M. Page.

The indifferent play of men on the previous day may have had a detrimental effect on the ladies, for they finished last. Results: Te Puke 15 points; Springfield 11; Rotorua Taupo 10.

SENIOR BASKETBALL

There was only one senior basketball match played in Taupo last weekend and that was between Kiwis and McLeod. Kiwis won the game 22-11 with a score, however, was no indication of the game. Hilda A. (Metro), Beverley McIn (Spa), Emma Rewa and P. mena Livesy (Kiwis) were chosen by the Putaruru selectors to feature in the representative trials for the New Zealand tournament.

A friendly game between Taupo primary and Waitahanui schools resulted in a win for Waitahanui 5-4.

FOR FRIENDLY AND CONSIDERATE SERVICE — CONSULT

ROOFING IRON

ALL SIZES AVAILABLE

SPROUTING RIDGING and

Stories For

Tau po m
Borough Coun
the tennis cou
discussion rou

The matter w
before the Elect
which, however,
small number
present at the
probable high co
referred it bac
council meeting.

The Mayor, M
opened discussi
did not think th
"beat about the
could not see fi
available this
commitments w
any expenditure
of the next seas
Opposing the
was Cr. J. M. S
the tennis club t
of the work wo
vicinity of £400.
such courts wou

WOMEN'S GOLF WAS L.G.U. AND MEDAL

On Thursday, the women's golf competition was for the L.G.U. and medal trophy.

The results were:

Silver division: Mrs B. Dawson, 91-14, 77; Mrs G. W. Foote, 85-6, 79; Mrs B. E. Bennett, 88-9, 79.

Bronze division: Miss N. Hesketh, 94-22, 72; Mrs J. Watson, 96-22, 74; Mrs C. Colson, 94-19, 75; Mrs D. Nelson, 99-24, 75; Mrs M. Sefton, 103-28, 75.

It will be seen that the best performance came from the bronze division, and Miss Hesketh's nett 72 earned her a reduction of handicap to 21. A comparatively new golfer, Miss Hesketh, approaches the game with enthusiasm and determination, yet maintains a cheerful demeanour, win or lose. While playing dead on her handicap, it was no doubt the fact that she unexpectedly three-putted on each of the 17th and 18th holes, that resulted in her being awarded a lower handicap.

BASKETBALL NEWS FROM ATIAMURI

On Saturday, Pohuturoa played Bisons on Court No. 1. Pohuturoa was leading in goals all the way. Their former Auckland suburb goal keeper, B. McKerchar, played superbly and proved herself to be the mainstay of the team. R. Tangira and M. Te Tomo played well. The final score, Pohuturoa 31, Bisons 16.

Pohara versus Pohuturoa was a most exciting game for the players and the spectators. There were fast passes, and spectacular goal throwing by both teams. The speed of the play tended to make it a little rough at times, but on the whole, basketball was really seen at its best in this game. Pohara won, 25-22.

The association are proud of the two girls who have been selected to represent Putaruru B Association at Invercargill. They are B. McKerchar and E. Terei.

The association raffle was won by A. Newton.

It is with regret that the association announces basketball will not be played on Sundays in future, owing to one team not being available.

WAIRAKEI SOCCER TEAM BEATS KAWERAU SIDE

At Kaimanawa Reserve on Sunday a soccer match between Wairakei and Kawerau resulted in a six to nil victory for Wairakei.

Wairakei also fielded two new players in Kilsy and Brewer. At centre half, Kilsy proved himself to be a player of merit. With only five minutes of the game gone, a corner was awarded to Wairakei from which Henry opened the scoring with a first-time shot, giving Kawerau's goalkeeper no chance. Griffiths added number two with a nicely placed shot. When Kawerau's centre half misjudged a high ball, Parker was there to add No. 3.

Half-time: Wairakei 3, Kawerau 0.

In a seven-minute spell in the second half, Wairakei added another three goals through Brewer, Parker and Griffiths. Although Wairakei deserved their win, the game was not so one-sided as the score suggests. If Kawerau finishing had been matched by their very good midfield play their margin of defeat would not have been so great.

Referee: Mr J. Foster.

TAUPO CAR CLUB

Tau po Car Club will hold a film evening for members and families on Wednesday, July 1, at 7.30 p.m. in the Fletcher Hall. Films will be of motor racing and general interest.

A mystery run and picnic will be held on Sunday, July 5, when an unusual event, full of fun, has been planned. The route will cover about 60 miles and will combine a treasure hunt, trial and driving tests.

MIDDLEMORE MUGS GO WELL INTO COMPETITION

On Saturday, Taupo Golf Club played the first round of the Middlemore Mugs Competition.

H. F. Fearn and C. B. Lowes beat L. H. Cheal and C. Colson, K. Rameka and V. Wilson beat C. Wroth and E. J. Ryan, R. Levick and D. Dawson beat L. Biddiss and L. O'Connor, A. Wallis and H. Mullins beat D. R. Logan and G. A. West; E. M. Smith and T. Leech beat G. Thomas and K. Thomas, G. F. Colbeck and W. T. Irvine beat D. Blue and T. O'Neill, C. W. Steele and D. Todd beat T. Price and F. Sherning, B. Dawson and C. Smith beat A. Aplin and O. R. Morgan, R. Reid and E. Farrell beat G. Gordon and J. Morel, G. MacDonell and P. A. Kunac a bye.

The draw for the second round of this competition to be played on July 4, is:

B. Dawson and C. Smith v R. Levick and D. Dawson, E. M. Smith and T. Leech v H. F. Fearn and C. B. Lowes.

The remainder have byes and pass into the third round to play as follows:

R. Reid and E. Farrell v A. Wallis and H. Mullins, C. W. Steele and D. Todd v G. F. Colbeck and W. T. Irvine, K. Rameka and V. Wilson v G. MacDonell and P. A. Kunac.

destroyed the opposition (Colk so that Steele administer the the 17th.

Sunday's - stal a win for a nev Freundlich, who of 35 points. Hi should not go u handicapper.

Teams from women's section ruru on Sunday annual inter-cl Usually, Taupo but on this oc formed much beaten by 13 g one halved. Act members, who a mainstay of Tau unexpectedly fa R. Logan and M foursomes prov winning game.

Results:
Men, Putaruru
Women, Puta

The feature
George Barlo (against the cc giving him a r not always give from home, but he played supe it is clear that later on seek t

Te Puke 29-6

l on the Taupo points to six. l an enterprising phases of play,

x: Penalties, two zie.

McKenzie, Wood- l, Wills, Tamahine, McNaughton, D. Manners, Hansen, Whare, Taylor,

mour, Retiti, Mc-Balmforth, Downs, s, Wall, B. Koopu, George, Hemara,

aln-raiser
ior curtain-raiser
Te Puke by 13

s by S. Smith, M. Darlington, Con. two).

Penalty by M.

I REPS. H.B. IALS

ig are the players present the Taupo y team in the Maori Sub-union ngs on Wednesday,

L. Erickson, L. Reid, T. Rameka, Wall, G. Koopu, C. pua, G. Ellis, T. ner, S. Hemara, A. tley, R. Rameka, T. er, B. Tuiri.

r not available
R. Morehu.

MARY RUGBY TOURNAMENT

10-a-side primary y half over, it is s year the standard ry schools is very

boys have their resenting Taupo in eld tournament at year.

hose people who ch Saturday morn- the primary school a see fast, exciting

th end of the lake, s strong as ever, boys are smaller years — but just

games for his team. In the for- wards John Te Waa is in good form: Dick Rihia seems to have a chance as a representative full-back.

Coming up the lake to Waita- hanui, the team is, as always, handicapped by having to call on boys who are too small. The bigger boys, used to playing amongst smaller ones, tend to run at only half-speed in their competition matches. North of Taupo at Maroa is an attacking team which has scored more points in the competition than any other so far. At five-eighth, Wally Seymour has many tries to

Being the bigger school, Taupo naturally has more talent to pick from. Of the two teams, Green, led by George Whiu has shown the better form. At halfback position, Ken Darlington is one of the team's main strengths on defence and attack. He and George Whiu together have scored most of the team's tries. George Blake and Paki Blake are speedy wingers, while Peter Darlington is a game forward. In the Yellow team the strength lies in the leadership of Michael Stephens and the hooking of Paddy Christensen.

While not eligible for the Ross Shield football, the boys of the

THES CLEANED
EFFICIENT WAY
CLEANERS

Drapery.
 NATIONAL PARK: Lynghang's Store.
 MAROA: McMillan's Store.
 TE HAROTO: North's Store.

O R D

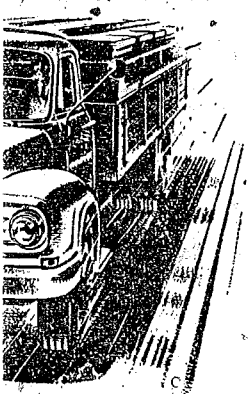

ST TRUCK VALUE

PO LTD.

Street Phone 557

RE at



ALS

Salisbury
SANDWICH PASTES
 4oz Jars
 1/7

TAUPO TABLE TENNIS AT ROTORUA

On Thursday, the St. Andrew's Table Tennis Club played St. Michael's at Rotorua. Those representing Taupo were: No. 1 team, R. Dryden, N. Jones, A. Alexiadis and T. Hansen. No. 2 team, Miss G. Cavaye, Mrs K. Watson, Miss U. Winterbottom and Mrs D. Dunn. No. 3 team, D. Loughlin, P. Garrett, S. Crowther and S. Croft. No. 4, Mrs Stanley, Miss Booth and Miss D. Stanley.

Results were:
 No. 1 team won by 11 matches to seven. Dryden and Alexiadis won all their matches. This team performed very well, as St. Michael's is the leading club in the Rotorua association.

No. 2 team won by ten matches to eight. This was also a good win for the Taupo women, as their opponents were men players.

No. 3 team lost by two matches to 16. The majority of these matches went to three sets, but St. Michael's were just too strong.

No. 4 team lost by eight matches to ten. Mrs Stanley played an outstanding game to win all but one match and that only by two points against a man player. The Taupo club spent a thoroughly enjoyable evening and are looking forward to a return match at a later date.

Officials of the Taupo Youth Centre Committee were placed in a somewhat embarrassing position on Saturday morning when collectors for the proposed house-to-house canvass did not turn up.

The collection was arranged by the Rotary Club of Taupo provided the centre committee could provide about 30 boys.

Arrangements were made through the high school and the boy scouts to have the youths on hand, but only nine turned up. Rotary and centre members were on hand with their vehicles to start the work but the collection was cancelled.

The centre committee wishes to apologise to members of the public and organisations which were inconvenienced on Saturday.

Asked to comment, the leader of the youth centre group, Sergeant N. Waters, of Taupo Police, said: "I can only say the collectors promised did not turn up. It was most disappointing."

IAN B. FORD
 Registered Plumber

WAIRAKEI LOSE AT SOCCER

Wairakei met Crusaders (Rotorua) in a very fast and entertaining soccer match on Kihirau Reserve on Saturday when the Rotorua team just succeeded in beating the local side 3-2.

It was a very hard-fought first half in which the attacks were switching from one end of the field to the other.

There were some near misses at both ends but at one time in particular, Crusaders came close when Gray crossed in front of Wairakei goal and Smith cleared off the goal-line. At the other end Cowie with a high shot at goal had Clark jumping and he just managed to get his fingers to touch the ball, sending it over the bar. Within minutes of the end of the first spell, Crusaders mounted another attack which Hands finished off by scoring from close in.

With 15 minutes of the second half under way, Crusaders increased the lead when Kelly shot and Murphy, who got his hands to the greasy ball, found he could not hold it and it twisted out of his grasp into the net. About this time Wairakei were doing everything but get the ball into the net and Rotorua did not have everything their own way.

Again Crusaders scored when Ukin beat Murphy with a high, well-placed shot. Wairakei persisted, and were ultimately rewarded when Farrell opened the scoring by shooting past Clark. Then Kilsley, who had been playing a very good game, beat Clark again with a very powerful shot.

The Taupo side were then all out for the equaliser and came very near when Smith brought the ball downfield and after passing to Kilsley, took the return pass, only to see the ball slip past the upright.

The teams were:

Wairakei: Murphy; Moore, Smith; Cowie, Henry, Griffiths; Brewer, Gallacher, Parker, Farrell, Kilsley.

Crusaders: Clark; Pirie, Mulberry; Faulds, Roberts, Ukin; Hands, Lowry, Nota, Kelly, Gray.

WHY let a stranger pick your shrubs? Come and choose your own from over 200 varieties. Taupo hardened. David Riley, Hinekura Avenue.

THE SP
 W.

LIQUOR

DAILY DE

Orders place before

All Leading Lin (sub

Phones 4
 After 6 p.m.: Re

MATER

Stocks of All Build
 Board, Pinex Har
 Roofing, I
 FIBROLITE M
 B

E.W. PIPES & FITT
 CONCRETE PIPES
 BRICKS—Fancy Su
 CHIMNEYS—Open
 SURROUNDS—Tile
 BOILERS—12 to 2
 WASH TUBS—Sing
 FOUNDATION PIL
 AIR VENTS
 BUILDING BLOCK
 TILES—Flooring R
 and Wall.
 GATES—Hurricane
 FLUSH DOORS—C

PAL

Pr
 ANVIL

Compl

FULL
 RU.

After Hours: W

On the Market Again —
PERRY'S FAMOUS

allowed him to. In the forwards, T. Percival, D. Reynolds, C. Crowther and M. Orr tried hard, but were overshadowed by a more fiery pack.

For the Past, in the backs T. Waldron (fullback), R. Fisher (wing), B. Garlick (five-eighths) and G. Newbold (halfback) stood out. Waldron with his safe handling and nice clearing kicks punctuated with judicious sorties into the backline proved the star of the backs. Fisher was always trying something, which made him a marked player, but nevertheless managed to score the try of the match when he flew in ten yards from the corner flag after he had received the ball from a Past attack in which the whole

SUCCESSFUL OPEN TOURNAMENT

Taupo Indoor Bowling Club's first open tournament was an outstanding success. Some 16 teams competed on the week-end for top honours in the tournament, coming from as far afield as Mangakino, Ngongotaha, Galatea, Ohakune and Atiamuri. The winning team was one from Mangakino and was skipped by Meek. Runner-up was another Mangakino team, skipped by Mrs Brightwell, while a consolation prize was won by the Taupo team skipped by Tom McMillan. Mrs Brightwell also won a competition. Morning and afternoon tea was served by the Taupo women members.

Thirty-two players took part in the weekly indoor bowling tournament on Monday evening when the highest scores returned were: Men, F. Tier (s). Women, Mrs D. Houghton. Booby prizes went to W. Harris and Mrs Harris.

BROWN SHIELD

All soccer enthusiasts of the Rotorua-Taupo sub-associations and, in fact, throughout the Bay of Plenty, are looking forward to an exciting game on Saturday, July 18, at Kuirau Park, Rotorua. Kick-off is at 2.30 p.m., between Bay of Plenty and Manawatu for the Brown Shield final. In 1953 the same teams competed and extra time was played to decide the victors.

Referee: Ted Levin, of Taupo.

Printed by East Waikato Publishers Limited at the Putaruru office of the company, 53 Kensington Street, Putaruru, and Published by Taupo Times Limited at its Registered Office, Heuheu Street, Taupo.

THURSDAY, JULY 16, 1959.

follows: W. Turetahi, G. Waters, H. Reid, S. Barron, G. Darlington, M. Gordine, M. Loughlin, A. Smith, J. Maniapoto, B. McLaughlin, T. Percival, H. Thompson, S. McKay, G. Mohi, A. Crowther. Reserves: K. Hurae, M. Nelson, K. Smith, G. Calvin, J. Smith, B. Cribb.

after Saturday.

Backs: R. Kahia, D. Rahia, J. Ellis, P. Blake, P. Kirikau, W. Seymore, M. Pomari, G. Whui, K. Darlington.

Forwards: J. Biddle, D. Airu, L. Fisher, J. Te Whaa, D. Rota, P. Hiki, M. Stevens, P. Christenson, A. Northcroft, H. Dixon.

Two Other Golfers "Do A Morgan" At End Of Day's Play

It was recently mentioned how often it happens that Dick Morgan comes in at the tail of the field, only to disrupt the pleasant ruminations of those who felt sure they had won the competition.

There must be something in this playing last, for on Saturday and Sunday certain members beat Dick for the apparent advantage of being last out, and came in winners.

In the third round of the president's trophy on Saturday, no particularly good cards had been handed in when the majority of players had finished, and H. Mullens, J. Watson and E. Farrell, all with 73 points each, were feeling very pleased with themselves at heading the field.

Then out of the evening shadows emerged the Cryer Motors team, Austin Cryer and Geoff Gordon, accompanied by starter Cliff Colson, and into the clubhouse the latter came vociferously claiming that he had brought in the best card.

And he had, as Gordon had finished with a nett 67, thus making him a firm favourite for the winning of the president's trophy. There are others within striking distance, however, and the fourth and final round could provide an upset.

Gordon has been playing steadily throughout the season, and no one could have been more pleased than himself when it was announced that his handicap was now reduced to 18. Cryer brought in the second best card for the day with a nett 72.

Detailed results:

G. Gordon, 87-20 (67 nett); A. Cryer, 90-18, 72; H. Mullens, 97-24, 73; J. Watson, 89-16, 73; E. Farrell, 91-18, 73.

In the stableford competition on Sunday, Peter Longstaff was accepting with dignity the congratulations of members on his excellent stableford score of 37 points, and the certainty of its being a winner, when from the twilight outside Ron MacIntyre and Ed Whitaker quietly insinuated themselves into the clubhouse. MacIntyre had a rapt expression on his face, and well he might, as his card showed a

stableford score of 39 points, his nett being 66. His one disappointment was that handicapper MacDonell was not there to receive him as he felt sure that the latter would like to have told him something appropriate to the occasion.

Next Saturday the first qualifying round of the club championship will be held, and it will be interesting to see who tails the field on this occasion. However, all those competing must be on hand to start not later than 1.30 p.m.

Atiamuri Basketball

Basketball was played in brilliant sunshine on Saturday, July 11. Bisons played Te Awhina Reserves on court No. 1. Bisons won 34-5.

Te Awhina A beat Pohara 25-16.

Pohuturoa played Forest Products on court No. 2. Pohuturoa won 22-15.

The weekly raffle was won by Mrs Norah Taiawa.

The draw for July 18 is as follows:

Te Awhina A v Te Awhina B; Pohuturoa v Bisons; Pohara v N.Z. Forest Products.

July 25: Te Awhina B v Pohara; Pohuturoa v Te Awhina A; Bisons v N.Z. Forest Products. End of second round.

The Basketball Association held a very successful social in the Atiamuri Cinema Hall last Friday night, July 10. A large crowd attended, and during the evening the association's raffle of six cups, saucers and plates complete with stand, was drawn, and won by P. Ransfield.

COMPLET
SPA ROAD

J.

Amazing

These and

54" V

ANGORA. Usually
HOLEPROOF Wo

All Wool FROCKI
Usually 27/6

Pure Wool Grey BI

Pure Wool SLEEP

VICTORY RUGS

Baby COT MATTE

Single Bed MATTR

Double Bed MATT

COUNTRY

For th

J. M

1959 SEASON

WAIRAKEI TEAM 1959

team members:	Rotorua					
Arrowsmith, R.	6 a-side					
Brewer	y	1-Jun-59	rot Rotorua Crusaders	3 - 1	Phil Henry 2,A.Dewar	six a-side tournament final
Cowie, W.	y	7-Jun-59	a Whakatane	2 - 10	Imboden,Wade	
Dewar, A.	y	21-Jun-59	h Kawerau	6 - 0	Henry, Griffiths 2,Parker 2,Brewer	at Kaimanawa Reserve
Farrell	y	4-Jul-59	a Rotorua Crusaders	2 - 3	Farrell,Kilsey	
Gallacher, S.	y					
Griffiths, G.	y					
Henry, P.	y					
Imboden, W.						
Kilsey						
Mason, H.						
Matthews, W.						
Moore						
Murphy, A. (gk)						
Parker						
Smith						
Wade, F.						

P.Henry, W.Cowie & G.Griffiths selected for BOP rep trial

1960

NO SOCCER IN TAUPO

PIONEER

Quality, ed Chain-saws

OF 1960 MODELS R DEALERS!



PIONEER MODEL '400'

THE NEW REVOLUTIONARY SABRE-GRIP CHAIN-SAW FOR CUTTING FIRE-WOOD — PULP CUTTING — CLEARING BRUSH — PRUNING etc. 12", 16" and 20" CUTTER BARS.

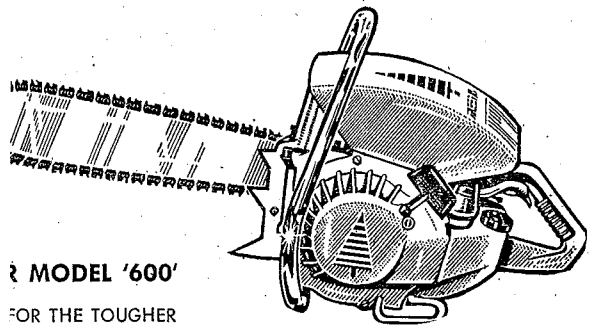

MODEL '600'

FOR THE TOUGHER
32" CUTTER BARS.



FROM ONLY

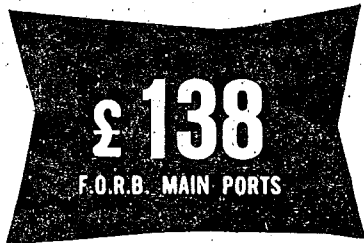

MODEL '800'

THE "BIG TIMBER," RUGGED DESIGN — REVELS IN HARD
26", 32", 40" and 50" CUTTER BARS.

er Chain Saw. Yet
d. Here you have
combination proved
or, direct drive that
guide bar for extra
keep their cutting
an investment that



(Formerly I.E.I. Pioneer)
Marketed by Pioneer Saws Ltd. A
wholly owned subsidiary of the
Outboard Marine International S.A.
Proprietors of the famous Johnson,
Evinrude outboard motors, etc.

THE-SPOT SERVICE

Inter-School Basketball Tournament

The following are the results
of the inter-school basketball
tournament played on Friday:

Senior: Waitahunui 4, Tauhara
(4) 2; Tokaanu 8, Wairakei 2;
Maroa 5, Oruanui 3; Tauhara (1)
13, Maroa 1; Taupo Green 7,
Tauhara (3) 1; Taupo Gold 6,
Tauhara (2) 3; Tauhara (2) 9,
Waitahunui 6; Taupo Blue 2,
Tauhara (1) 9; Wairakei 2,
Tauhara (3) 5; Taupo Red 5,
Tokaanu 0; Taupo Gold 4,
Tauhara (4) 0; Taupo Mauve 1,
Oruanui 5, Tokaanu 1, Taupo
Green 7; Taupo Red 2, Wairakei
2; Taupo Blue 5, Oruanui 2;
Taupo Mauve 1, Maroa 8; Waita-
hunui 2, Taupo Gold 6; Tauhara
(2) 5, Tauhara (4) 2; Tauhara (1)
5, Taupo Red 3; Taupo Mauve 0,
Taupo Green 2; Taupo Blue 5,
Tauhara (3) 2.

Junior: Tauhara (1) 6, Taupo
Green 4; Wairakei 4, Waitahunui
5; Tauhara (2) 1, Tokaanu 9;
Taupo Blue 1, Mokai 18; Taupo
Red 2, Maroa 1; Tauhara (3) 6,
Oruanui 5; Taupo Gold 6, Maroa
0; Taupo Green 5, Waitahunui 0;
Tauhara (1) 5, Wairakei 3; Taupo
Blue 3, Tauhara (3) 10; Taupo
Red 3, Taupo Gold 3.

Indoor Bowling Matches

On Sunday, the Taupo Indoor
Bowling Club played a series of
matches with nine teams contest-
ing for the open championship
fours. After some excellent and
closely contested games, five
teams had qualified by lunch
time.

The afternoon games were
very keen and close, with Mr T.
McWilliams' team being the only
unbeaten players of the day. The
team comprised Mr T. McWil-
liams, Mrs M. Humphries, Mrs P.
Vernon and Mrs R. McKenzie.
The runner-up team consisted of
Mrs Nichols, Mrs Tierney, Mrs
McMillan and Mrs Edwards.

Those to gain the highest
points for Monday evening were
Women: Mrs Currie; men: Mr G.
Rameka.

TAUPO INDOOR BASKETBALL

Taupo indoor basketball draw
for tonight (Friday) is as follows:
7 p.m., Wairakei v. Flamingoes
(J. Dean and H. Otene); 7.30 p.m.,
Saints v. Yachties (H. Otene and

CHATHAM CUP SOCCER

The Bay of Plenty champion of
champions soccer winners,
Kahukura, will be fielding young
members in their team against
Auckland's well-known North
Shore team, who have Ken Arm-
strong and several other out-
standing players in the Chatham
Cup semi-final at Rotorua on
Saturday.

Kahukura's victorious games
against classic teams such as
Eastern Union (Poverty Bay) and
Hamilton Technical (Waikato)
prove that all the supporters of
the Bay of Plenty should muster
in full strength to cheer their
team on on Saturday. Mr A.
Angel, formerly a British Army
representative player, is the
coach.

The stands and area can easily
cope with the expected 2000 sup-
porters (and New Zealand selec-
tors) to witness an interesting
game of soccer. No charge will
be made at the gate.

Kick-off is at 2.30 p.m., Kiurau
Park, Rotorua, on Saturday.
Referee: Mr Ted Levin, Taupo.

Basketball Draw For Saturday

The following is the basketball
draw for Saturday, July 23:

Senior: College C v. College B,
12.30 (P. Shea); Kiwi v. College C,
1.10 (H. Finlinson); College A v.
T.O.G., 1.45 (M. Smith); Kiwi v.
Youth Club, 2.15 (E. Rewa); Col-
lege v. Youth Club, 3.10 (L.
Vernon).

Intermediate: Tauhara A v.
College 1, 12.30 (E. Rewa); Tau-
hara B v. College 2, 12.30 (H. Fin-
linson); Primary B v. College 1,
1.10 (A. Delaney); Primary A v.
Tauhara B, 1.10 (M. Smith);
Tauhara A v. College 2, 1.45 (E.
Rewa); Primary B v. Tauhara B,
1.45 (H. Finlinson).

FISHING

Trawling and fly fishing in the
Rangitira-Mine Bay area has
been exceptionally good lately.
Some fine catches have been
taken and the trout have been in
excellent condition.

This Space is

SHOP ON

Red Da

Sutton's

POT. PR

R.M.

FOR QA



VICTOR, i
good t

CONSUL
all dep

VELOX, 1
A bar
deposi

C.A. VAN
the m
Depos

MODEL
Econo
Depos

ALEX

REFRIGERATORS,

1961

NO SOCCER IN TAUPO